

World **SOCCER**

FINALS

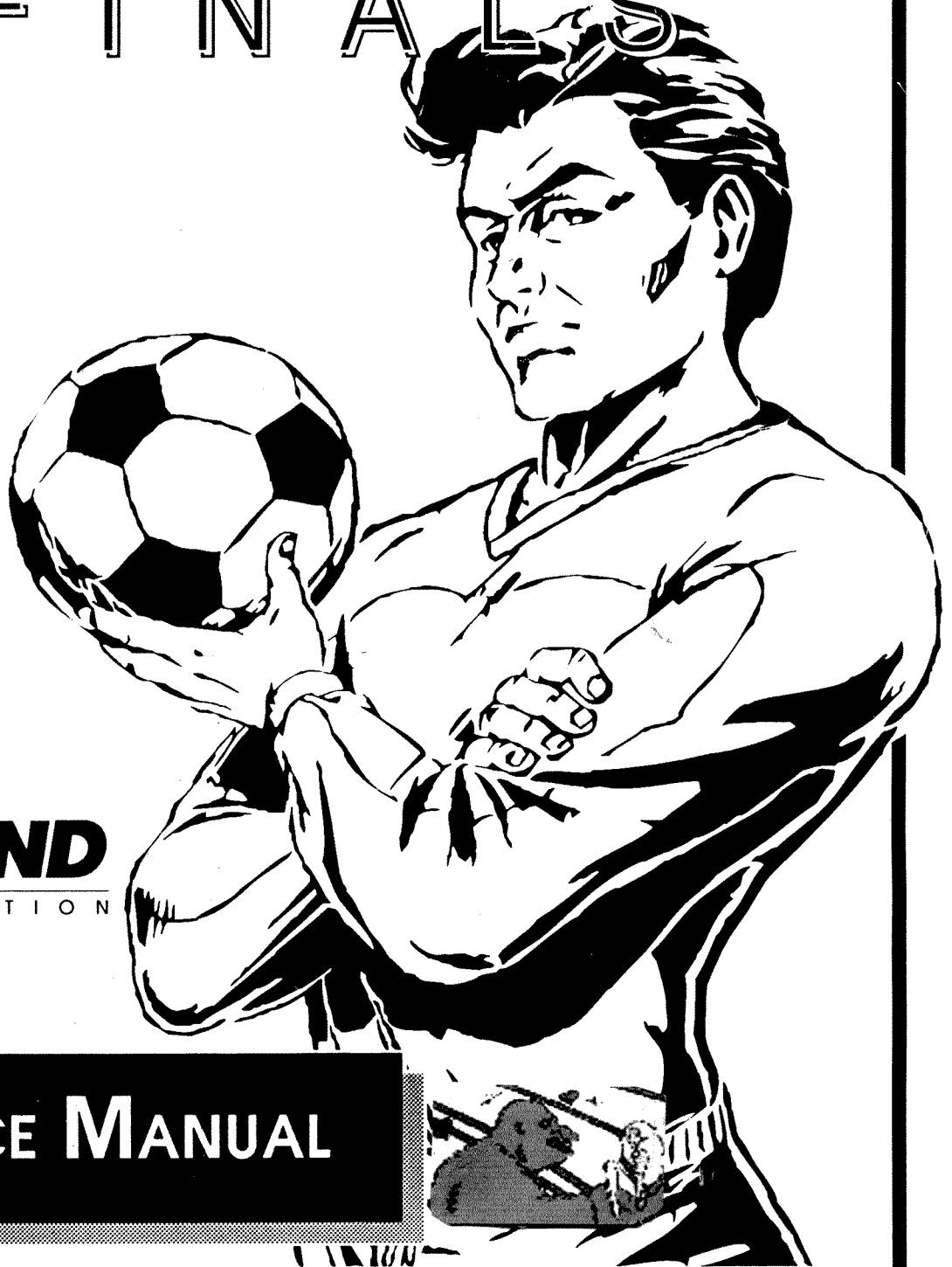

LELAND
CORPORATION

SERVICE MANUAL

.....

Your Responsibility for Maintenance

It is the owner's responsibility to make sure that the specified maintenance is performed. The Troubleshooting Section of this manual provides details on these maintenance requirements. Also included in the Troubleshooting Section is information regarding other requirements for games operated under severe playing conditions.

Machine Information

Purchase Date: _____

Distributor: _____

Game Serial Numbers

Program: _____
(see lower left corner of bookkeeping main menu screen)

Game Board: _____

Cabinet: _____

Introduction

Welcome to the growing number of value conscious people who operate Leland Corporation products. We are proud of the advanced engineering and quality of each product we build.

Please take a few moments to read through this manual. It has been designed to acquaint you with the features of your new World Soccer Finals™ game and to help you make the most profit from this machine.

When it comes to service, remember that your Authorized Leland Distributor knows your game best and is dedicated to your complete satisfaction. He can provide quality parts, service, and any other assistance you may require.

The Leland Corporation

Please leave this owner's manual in the game at the time of resale. The next owner will also need this important information.

All information and specifications in this manual are current at the time of printing. However, because of The Leland Corporation's policy of continual product improvement, we reserve the right to make changes at any time without notice.

Non-Leland Replacement Parts Notice

The Leland Corporation recommends the use of genuine Leland Corporation parts when replacing any malfunctioning component or assembly in this game. For safety and reliability, The Leland Corporation does not recommend or authorize any substitution parts or modifications of Leland equipment. Such alterations may adversely affect game play or cause serious injury, and will void your warranty. Unauthorized parts and/or modifications may also void FCC compliance.

FCC Warning

This equipment generates, uses, and can radiate radio frequency energy and if not installed in accordance with the Owner's Manual, may cause interference to radio communications. This game has been tested and found to comply with the limits for a Class "A" computing device pursuant to subpart "J" of part 15 of the FCC rules, which are designed to provide reasonable protection against such interference when operated in a commercial environment. Operation of this equipment in a residential area is likely to cause interference, in which case the user, at his own expense, will be responsible to correct the interference.

.....

World Soccer *Finals*[™]

Table of Contents

General Game Information	Page
Game Concept	5
Features	6
Assembly Instructions	7
Maintenance and Upkeep	8
Troubleshooting	9
A Note About Power	9
Our Service Department	9
Troubleshooting Flow Chart	10
Troubleshooting Tips	11
About Mechanical Coin Counters	12
Bookkeeping & Diagnostics	13
Cabinet Wiring Diagram	19
Wiring Diagrams	20
Illustrated Parts List	26
Warranty Information	28

World Soccer *Finals*[™] **Game Concept**

It's the thundering, pummeling excitement of World Soccer Finals! Now up to four players can get in on all the great action of this international field sport.

Players can choose their favorite country from a world roster of teams and then challenge one another through several rounds of fun-filled play as they battle their way through the finals and on to the gold cup!

Team work is the name of the game here as players choose up sides and then jump into the fray! New players can join in at any time. Single players will find the game microprocessor a worthy opponent!

Game action takes place up, down and across the field as the two teams pound the turf from one goal net to the other—kicking, blocking, passing, and running—with all the action and bone-jarring sound effects of a major league soccer exhibition.

For all the fun and excitement of international soccer, World Soccer Finals puts it into the net and scores!

Features Information

Precise 8-Way Joystick

Controls player movement up, down and across the playing field

"A" and "B" Buttons

If You Have the Ball on the Field:

Button A to kick the ball on the ground

Button B to kick the ball in the air

A + B to run past opponent while kicking the ball

If Your Opponent has the Ball:

Button A to knock down opponent and take ball

Button B to kick ball past opponent

If Ball Comes Toward You:

Button A to block or hit ball with head

Button B to jump into air

A + B to kick ball away

If you are the Goalie and Don't Have the Ball:

Button A to block ball by diving sideways

Button B to jump up to catch ball

If you are the Goalie and Do Have the Ball:

Button A to kick ball onto field

Button B to roll ball along ground

A+B to throw ball through the air

Control actions are accompanied by an assortment of realistic game sounds! Play is punctuated by the referee's whistle and the roar of the crowd. As a player advances towards the World Cup, the "national anthem" of his selected country will be played.

Assembly Instructions

1. Remove all parts from the shipping containers and check them for damage. Notify your distributor (and the shipper) immediately if you find any parts broken.
2. Lift the monitor plexi and clean or dust any debris that may have settled on the monitor during shipping. This would also be a good time to gently wipe down the inside of the monitor plexi as well. Use only a soft, dry cloth to wipe the plexi to prevent scratching.
3. The front panel playing surface is hinged in front to facilitate easy access to the cabinet's interior. To open the panel, reach through the coin door and through the inner partition opening to the top two corners of the front panel's underside (see Fig 1). Release the latches and lift the rear edge of the panel. The panel will then swing down, providing complete access to all pushbuttons and joysticks. The game circuit board and power supply are accessed through the lockable rear panel.

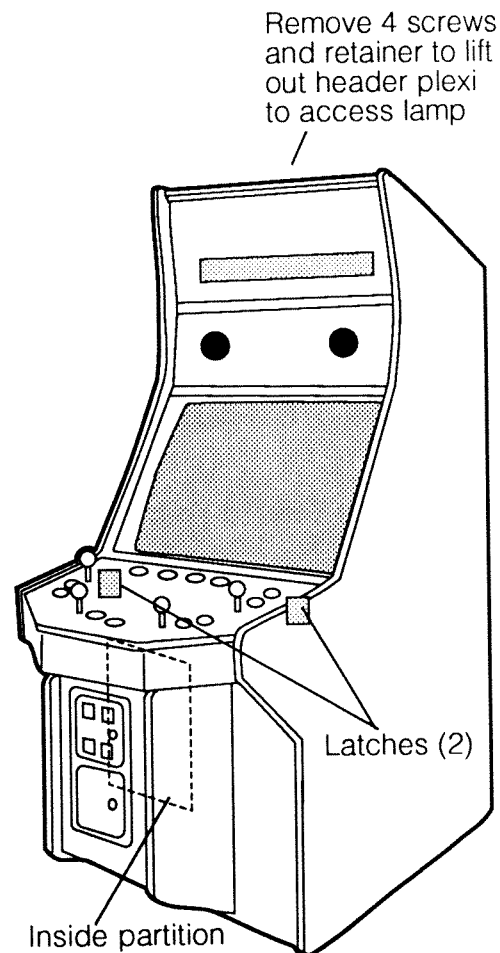

Fig. 1
Front Panel Latch Location

Maintenance and Upkeep

Maintaining your World Soccer Finals™ game is of utmost importance in order to enjoy good, steady earnings. A dirty cabinet, sticky coin mech, or poorly adjusted player controls are all suspect when a significant drop in revenue is noticed.

The following are recommended procedures to follow when servicing your machine:

Every Collection—

Make sure that the cabinet and especially the control panel and glass are clean and free of gum, grease, and dirt.

Play the game. Check the joysticks and buttons for proper adjustment and response (see the buttons and controls test in the Diagnostics sections).

NOTE: Be sure to adjust, clean, or replace any marginal switches.

Clean and adjust the monitor to ensure that the picture is "rich" and inviting.

Once a Month—

Check the inside of the cabinet for dirt and dust.

HINT: Carry a portable "Dustbuster"-type vacuum.

See that all electrical connections are properly seated.

Go through all diagnostic functions to ensure proper operation and inspect game settings.

Make certain that the power supply is operating properly. (See "A Note About Power" on Page 9.)

At first these steps may seem annoying or excessive, but when viewed with respect to the income generated by a clean, well-maintained machine (as opposed to income lost by a dirty, "trashed" game), the benefit of spending a few extra minutes will be seen as a wise investment.

Troubleshooting

A Note About Power

DC Power

The microprocessor in this machine operates most efficiently when the power supply is providing a steady +5.00 VDC to 5.05 VDC. When checking the DC power, always put your leads across the +5 VDC test points on the main circuit board (**NOT** at the power supply, DC input connector or any IC-- see Fig. 2, Page 11) and be sure that the +5 volt supply is between +5.00 VDC and +5.05 VDC, and that the -5 and +12 Volt supplies are within $\pm 1\%$ of nominal value. Also, be sure that there is less than .005 volts AC riding on the +5 volt, -5 volt and +12 volt lines. If you do find AC on the DC line, inspect the filter capacitor or the rectifier on the power supply. Low voltage and AC on the DC lines are the main causes of the following problems:

- "Garbage" on the monitor screen
- Computer freeze-up
- Coin or coin meter malfunction
- A variety of seemingly unrelated problems

AC Power

Connect this game only to a grounded three-wire outlet which provides between 108 and 132 volts AC. If you have only a two-wire outlet, we recommend that you hire a licensed electrician to install a grounded outlet. This will reduce the possibility of a player receiving a shock. The possibility exists that players may receive an electrical shock if this system is not properly grounded.

Our Service Department

For parts, service, and technical information, first contact your authorized Leland Corporation Distributor. If additional technical aid is required, please contact the Leland Corporation Customer Service Department at (619) 562-7000, Monday through Friday, 8:00 a.m. to 5:00 p.m. Pacific Time. **A technical manual on this product is available. Contact our Customer Service Department and order part number B-703-00006-00.**

To provide you with the quickest possible response to your questions, please have the following information ready when you call:

- Your game name and serial number
- Any reference materials and a list of observations.

Troubleshooting Flow Chart

Don't Touch That Switch!

Before you reach for the power switch, take a look at the game. Open it and check for loose wires, bad connections, or burned spots. Also look for spilled fluids or signs of vandalism. These quick checks could save you a lot of time.

Once you've eliminated the obvious, it's time to do some detective work.

Never take anything for granted. This is easy to do if you're in a hurry. Locating a broken wire or loose connection at the beginning could save you many expensive hours looking in the wrong place.

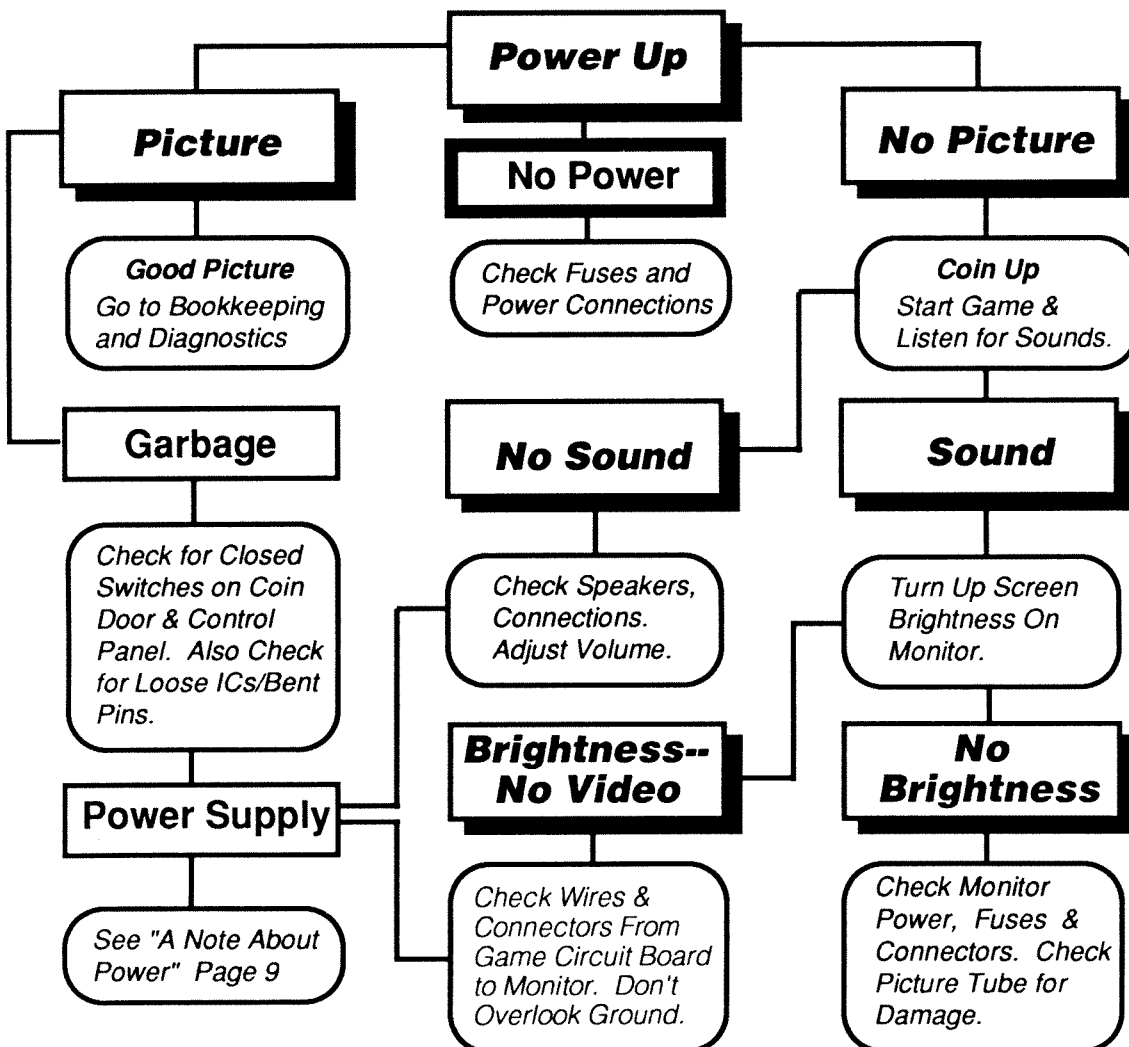

Troubleshooting Tips

General Troubleshooting

Monitor screen filled with "garbage"—

- Press SW1 on the game circuit board (logic reset, see Fig. 2).
- Check power supply voltages.
- Check closed switches on the control panel or coin door.
- Look for loose connections, loose ICs, or bent pins on the board.

No sound—

- Check for loose connections.
- Low +12 VDC supply.
- Bad speaker or volume pot.

No control or function switches (includes coin switches)—

- Check all connections (especially ground).
- Check wire continuity between board and switch.
- Look for closed or broken switches.
- Check the input buffers.

Monitor Troubleshooting

No picture—

- Check all power connections.
- Check monitor fuses.
- Check all video connections for continuity.

Sync problems—

- Check sync and ground connections.
- Check sync polarity.
- Check the video output buffer.

Important Note: Any authorized board repair or attempted repair will void your warranty! Refer to the Leland Corporation Limited Warranty statement at the back of this manual for restrictions and or limitations.

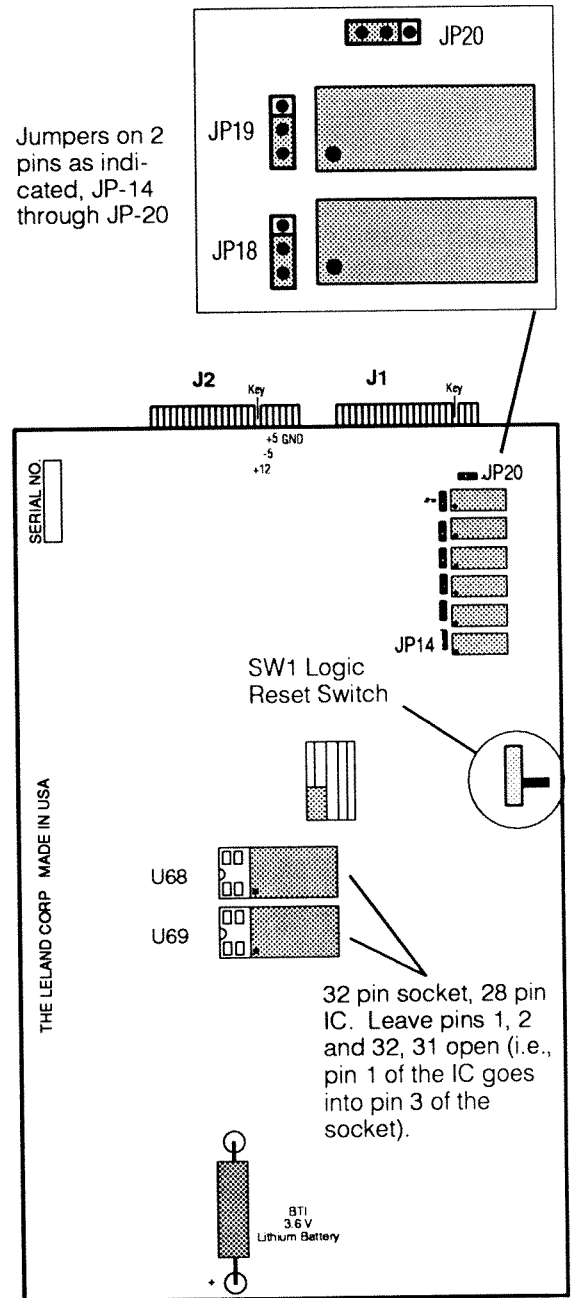

Fig. 2
Game Circuit Board

About Mechanical Coin Counters

We have not installed mechanical coin counters on this game for the following reasons:

- The bookkeeping program for this game is extremely accurate and includes not only the number of coins dropped and the dollars earned, but also keeps track of the number of tests and coins in a given period. (See "Bookkeeping" in the Diagnostics Section.)
- Mechanical coin counters can produce an inductive "kick" that could damage circuit board components, checkerboard video being the most common problem.

If your situation requires mechanical coin counters, please use the follow diagram. (Diodes may be 1N4001 or 1N4004.)

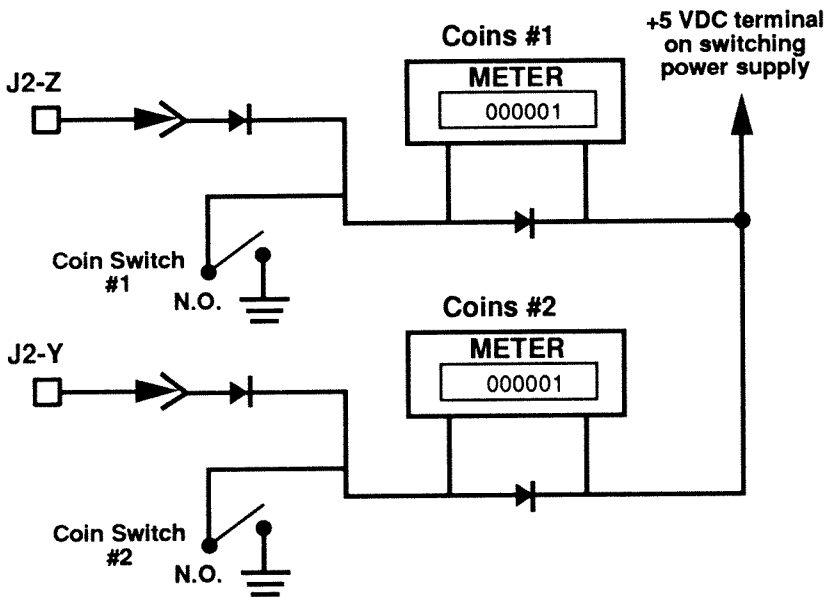

Fig. 3
Mechanical Coin Counters

Bookkeeping and Diagnostics

To enter the Bookkeeping and Diagnostics Sections:

- Press any "B" button on the control panel.
- Press and hold the service select button (located inside the front door— see Fig. 4).
- Release both buttons.

The Main Menu will appear on the screen. Follow the instructions on this menu to select and enter the desired function.

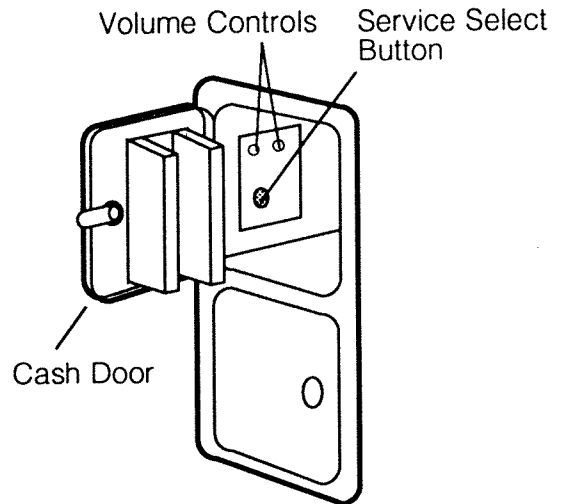

Fig. 4
Service Switch Location

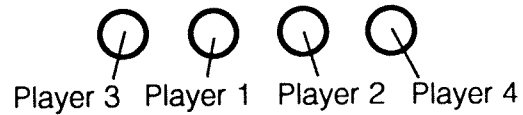

Fig. 5
Player Join Buttons (white)

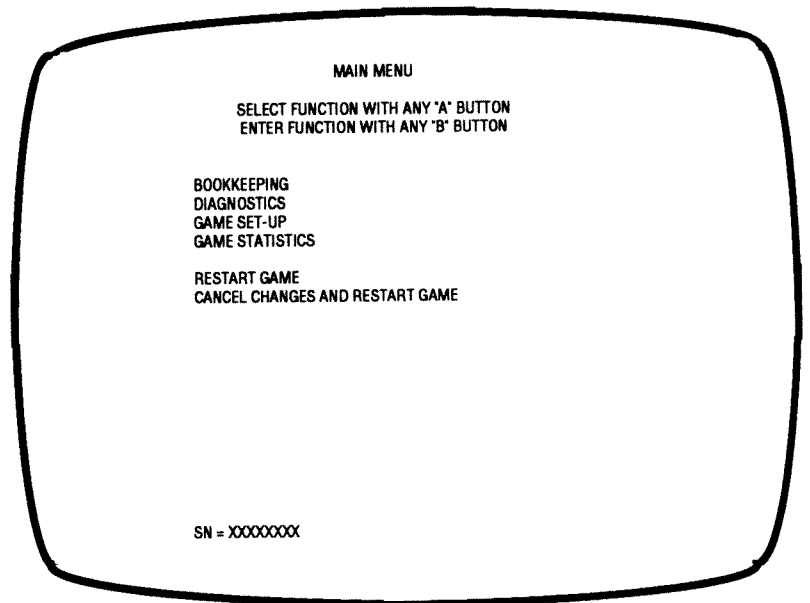

Fig. 6
Initial Service Screen

Bookkeeping

The Bookkeeping function is your game accountant. It records the lifetime earnings of your game and allows you to keep track of weekly, monthly, or location earnings by using the resettable "Period" totals.

NOTE: The "Set Coins/Tokens per dollar" category must be set to the location standard to maintain accurate accounting data (i.e., 6 coins/tokens per dollar).

This function does not affect the number of coins per credit. (See "Game Set-up" for further information.)

```

BOOKKEEPING
SELECT FUNCTION WITH ANY 'A' BUTTON
ENTER FUNCTION WITH ANY 'B' BUTTON

LIFETIME PERIOD
COINS COINS DOLLARS
COINS DROPPED - MECH 1 0 0 $0.00
COINS DROPPED - MECH 2 0 0 $0.00
COINS DROPPED - MECH 3 0 0 $0.00
COINS DROPPED - MECH 4 0 0 $0.00

TOTAL COINS DROPPED 0
SERVICE BUTTON PRESSED 0
TOTAL CREDITS GIVEN 0

RESET COIN MECH 1 DOLLARS COLLECTED --(SPARE)
RESET COIN MECH 2 DOLLARS COLLECTED --(LEFT COIN MECH)
RESET COIN MECH 3 DOLLARS COLLECTED --(RIGHT COIN MECH)
RESET COIN MECH 4 DOLLARS COLLECTED --(SPARE)

SET COINS/TOKENS PER DOLLAR:
4 COINS PER DOLLAR

RESET PERIOD TIMERS ON EXIT -- NO

RETURN TO MAIN MENU
    
```

Diagnostics Menu

Calling up the Diagnostics menu will open a very complete and easy-to-use set of tests to make adjusting, troubleshooting, and servicing your machine quick and simple.

You will notice that the diagnostics section has a sub-menu of its own.

```

DIAGNOSTICS

SELECT FUNCTION WITH ANY 'A' BUTTON
ENTER FUNCTION WITH ANY 'B' BUTTON

BUTTONS AND CONTROLS TEST
PROCESSOR MEMORY TEST
VIDEO ALIGNMENT TEST
AUDIO SUBSYSTEM TEST

RETURN TO MAIN MENU
    
```

Buttons and Controls Test

This test provides a quick examination of the condition of all player buttons and controls.

```

PRESS THE FOLLOWING BUTTONS:
PLAYER 1 JOIN CLOSED SPARE 1
PLAYER 2 JOIN OPEN SPARE 2
PLAYER 3 JOIN OPEN SPARE 3
PLAYER 4 JOIN OPEN

COIN MECH 1 OPEN
COIN MECH 2 OPEN
COIN MECH 3 OPEN
COIN MECH 4 OPEN

SERVICE SWITCH OPEN

PLAYER 1 SHOOT OPEN
PLAYER 1 PASS OPEN
PLAYER 2 SHOOT OPEN
PLAYER 2 PASS OPEN

PLAYER 3 SHOOT OPEN
PLAYER 3 PASS OPEN
PLAYER 4 SHOOT OPEN
PLAYER 4 PASS OPEN

PLAYER 1 JOYSTICK
UP LEFT DOWN RIGHT
PLAYER 3 JOYSTICK
UP LEFT DOWN RIGHT
PLAYER 2 JOYSTICK
UP LEFT DOWN RIGHT
PLAYER 4 JOYSTICK
UP LEFT DOWN RIGHT

PRESS PLAYER 3 JOIN BUTTON OR
SERVICE BUTTON TWICE TO EXIT.
    
```

Switch will show "CLOSED" when pressed.

Processor Memory Test

The erasable programmable read only memory (EPROM) and random access memory (RAM) ICs are storage areas for the actual game guidelines and are accessed by the microprocessor. The percentage of field failures in these areas is very low, but when problems do arise they can be difficult to track down. This processor memory test samples the action of the microprocessor and notes any malfunctions.

CAUTION: Read your limited warranty on the back cover of this document before attempting any printed circuit board repairs.

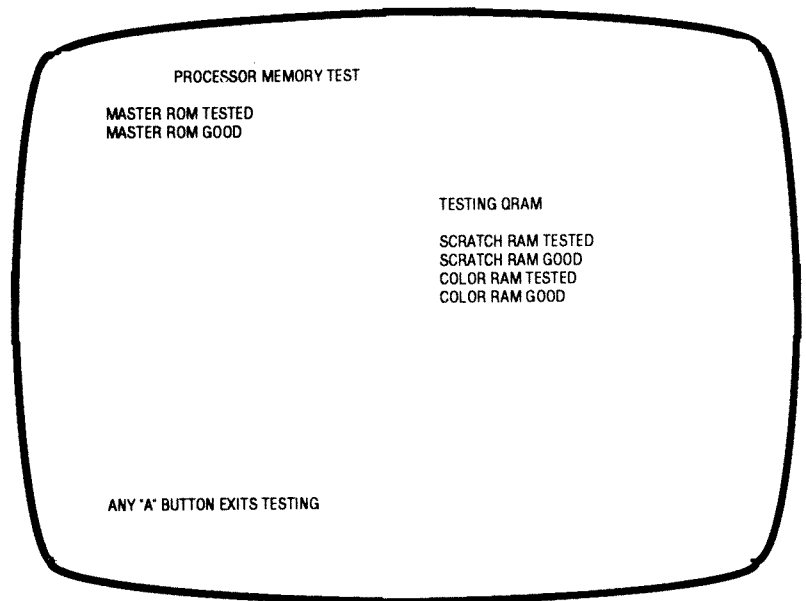

Video Alignment Screen

The picture on the video monitor is the most important and most neglected part of any game. It has been proven that a dirty, misaligned, or unfocused screen is the biggest cause for reduced collections—players will simply walk away if the game is not operating properly.

Use the cross hatch pattern to adjust focus, alignment, size, and contrast. Wavy vertical lines denote bad contrast. The screen's background should be black and the grid lines solid white.

The 4 "X"s denote the corners of the display. Because they are in the "pincushion" area, their shape is a good indicator of vertical and horizontal linearity. Any color fringing on the "X"s (or anywhere in the cross-hatch pattern) indicates a need for convergence.

"Rainbow" areas along the display's edges indicate that degaussing is needed. This condition is caused by moving the game with the power on. Your game has a built-in degaussing coil, however, it may take a while to work. For that reason it is suggested that a degaussing coil be carried in your service vehicle. Degaussing doesn't take much time and can make a big difference in the appearance of your game.

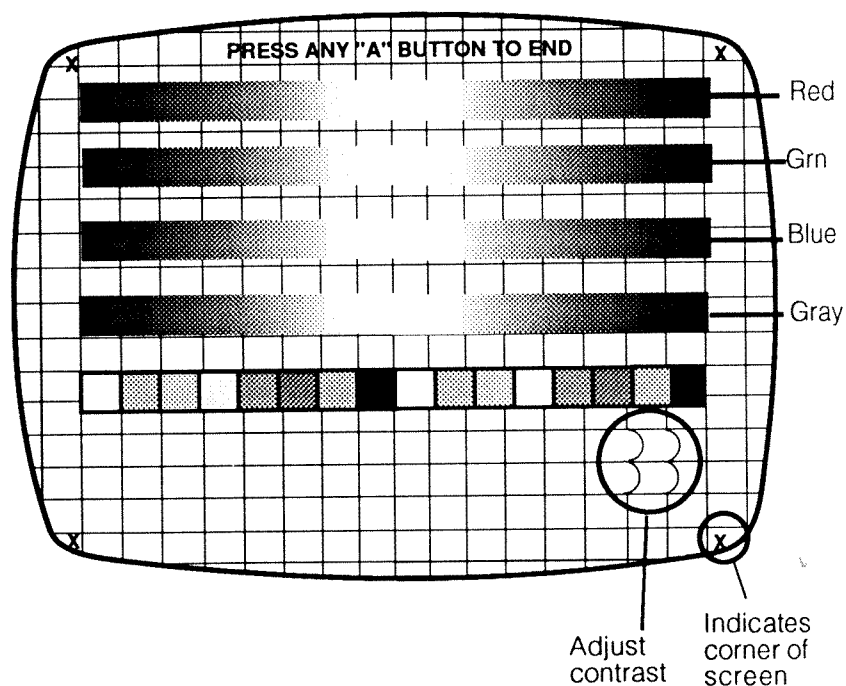

Adjust the screen or brightness control so that the green color bar shows green in the center and tapers to black on the ends.

Use the red cutoff control to adjust the red color bar to the same intensity as the green color bar.

Use the blue cutoff control to make the gray color bar appear gray (not brownish).

Adjust the red and green drive controls slightly to make the white blocks white.

Audio Subsystem Test

The sounds are the second most important feature of any game. The volume of the game's sound, for the most part, is dictated by the location. However, the quality of the sound is a function of the program. This test will help you in your quest to find "odd" sounds or to remedy the lack of certain sounds.

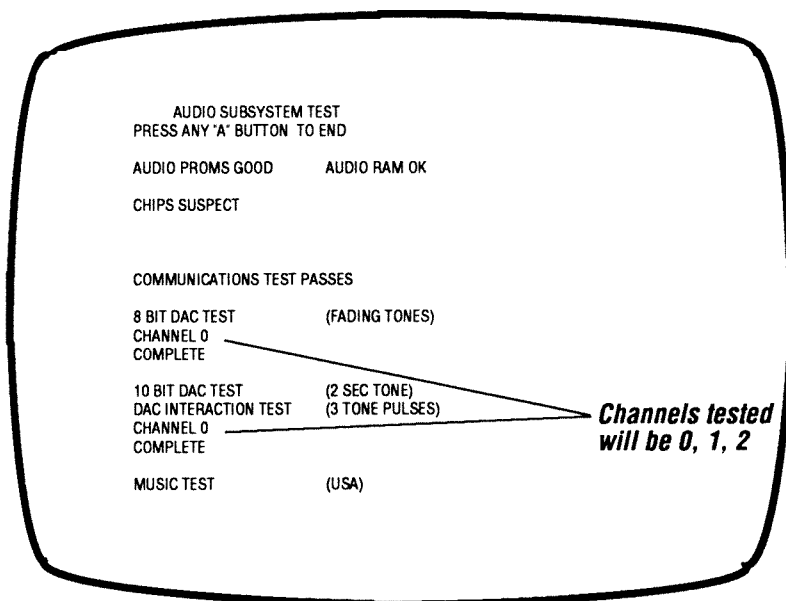

Game Set-up

This section is vital to the condition of your cashbox. When used in conjunction with the Bookkeeping section of the Diagnostics package, the Game Set-up function will keep your game on the top of your earners list. The coins-per-credit settings range from 1 coin/1 credit to 20 coins/20 credits. You may wish to set the two coin mechanisms differently, i.e., 1 coin/1 credit on one mech and 4 coins/5 credits on the other. Sometimes a little experimentation can pay off with improved collections. The play time-per-credit function sets the time in 30 second increments.

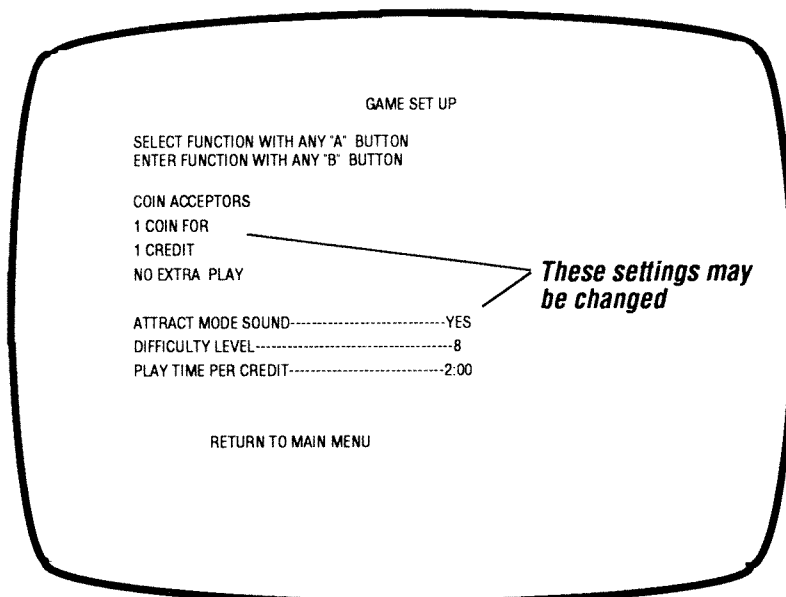

Statistics

This section is the gateway to other game accounting information. It contains three choices: Game Statistics (information on multiplayer play), Operation Statistics (game operation and play times), and Game Duration Statistics (average length of time game is being played).

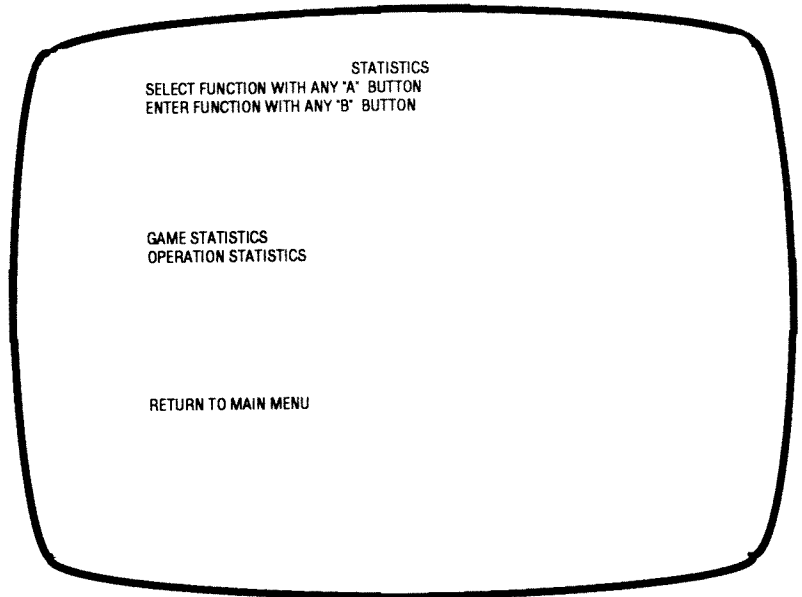

Game Statistics

This section lets you know how many single or multiplayer games took place. With this report, you can determine if the game is appealing to the largest number of multiplayers while in its current configuration.

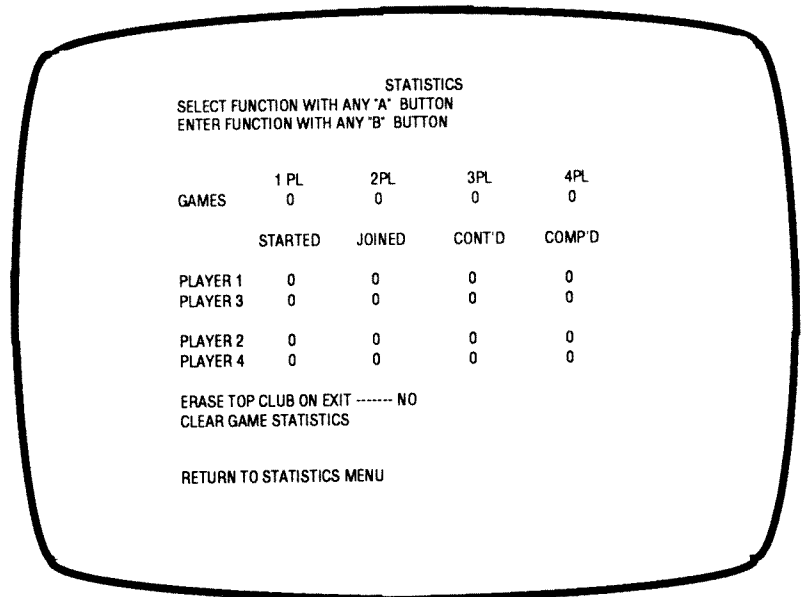

Operation Statistics

This section reports the real-time duration counters.

Play duration is the time that any number of players were playing. Operation duration is the time that the game was operating. **NOTE:** Please remember to reset the period counters when you reset period collections. You can find the following statistics:

Earnings-per-Hour— 24 hour days + hours + rounded off minutes, divided by period collections.

Game Efficiency— lifetime operation divided by lifetime play or lifetime play or period operation divided by period play.

Period timers are reset by pushing Select and then Enter. Lifetime timers will reset if the RAM battery circuit should fail.

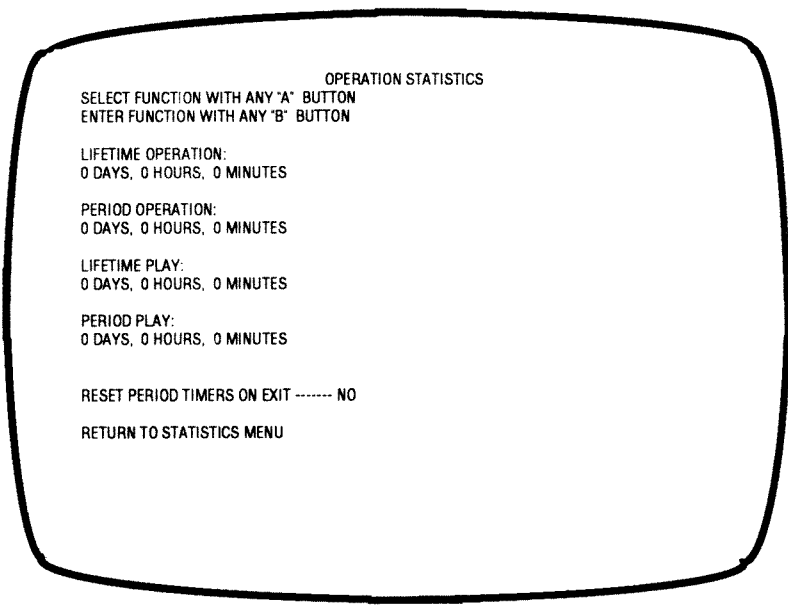

Cabinet Wiring Diagram

AC Power
 108 - 132 VAC
 2.5 A Max

DC Power
 +5 VDC @ 11A
 +12 VDC @ 2A
 -5 VDC @ 1A

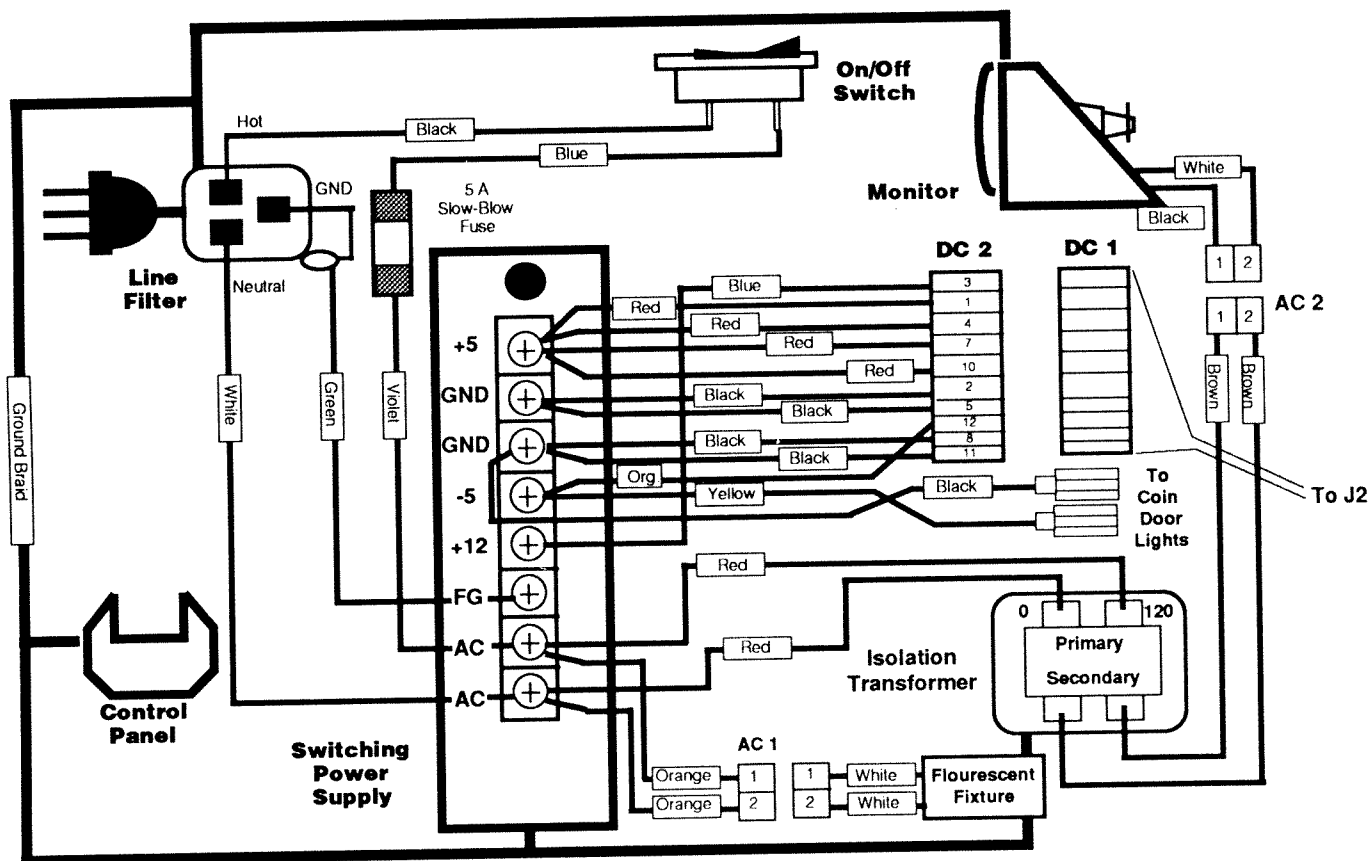

Video Connector Numbering

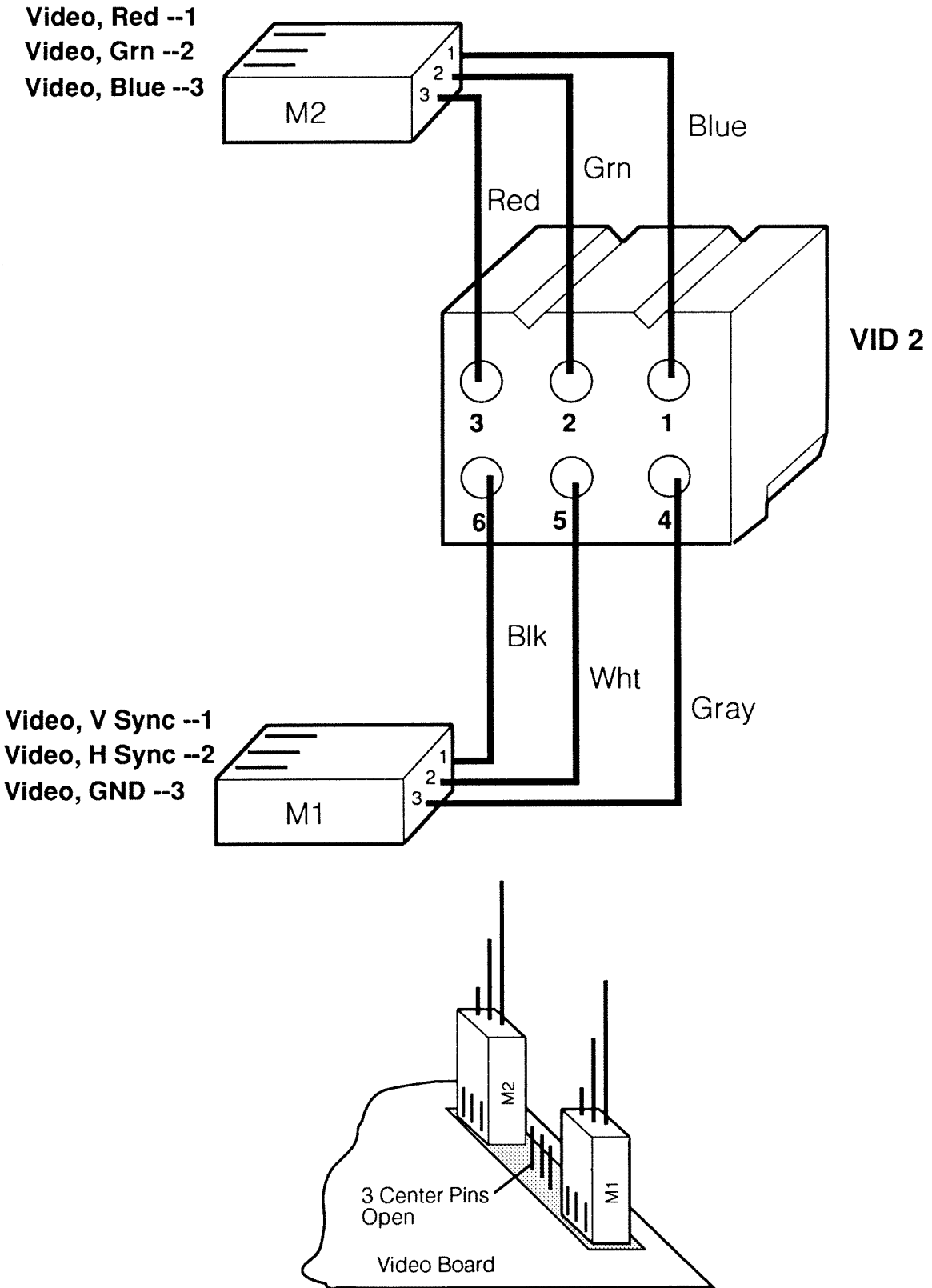

Speaker, Volume, Coin Lights

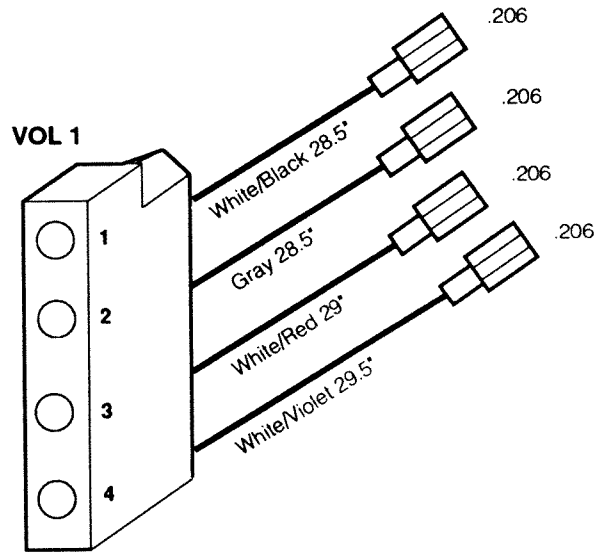

Service Switch, Coin Mech

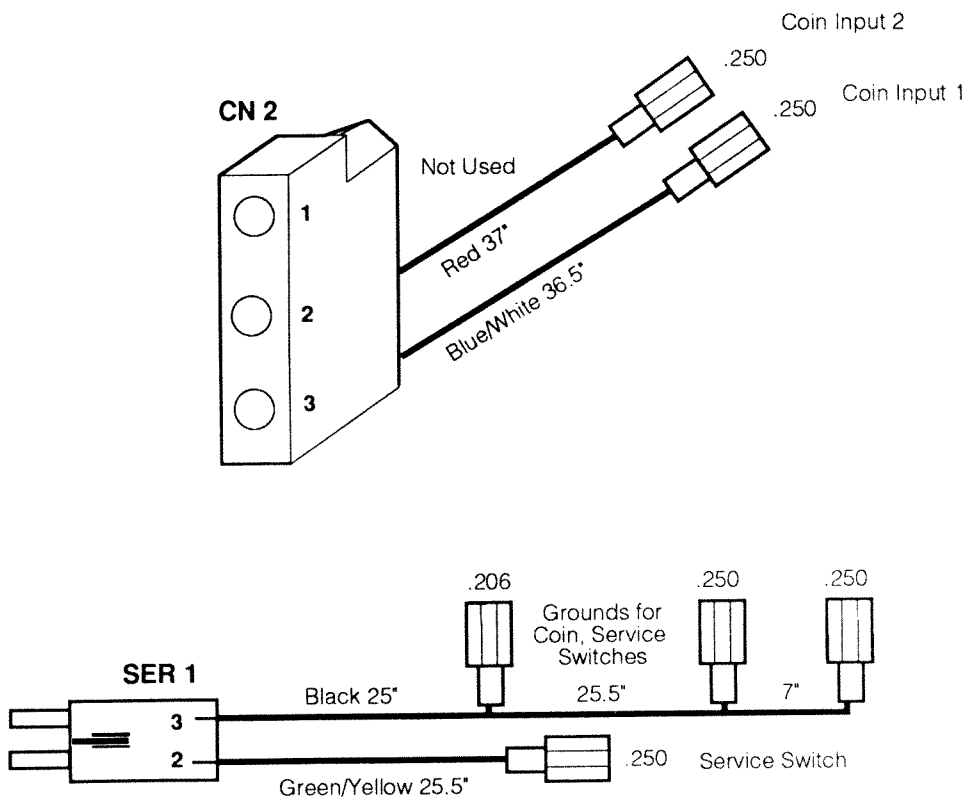

Game Board Wiring Diagram J1

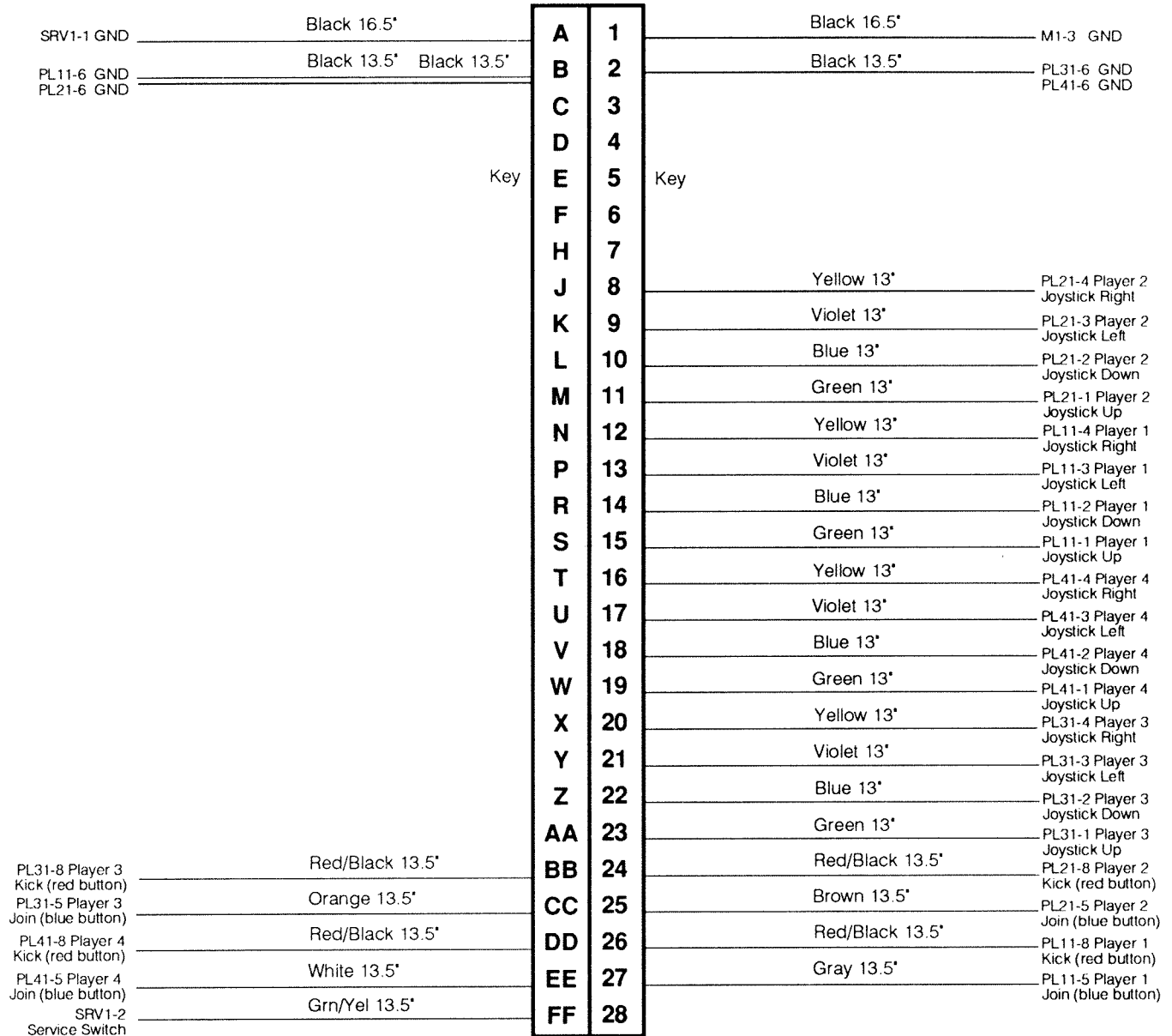

Speaker Wiring Diagram

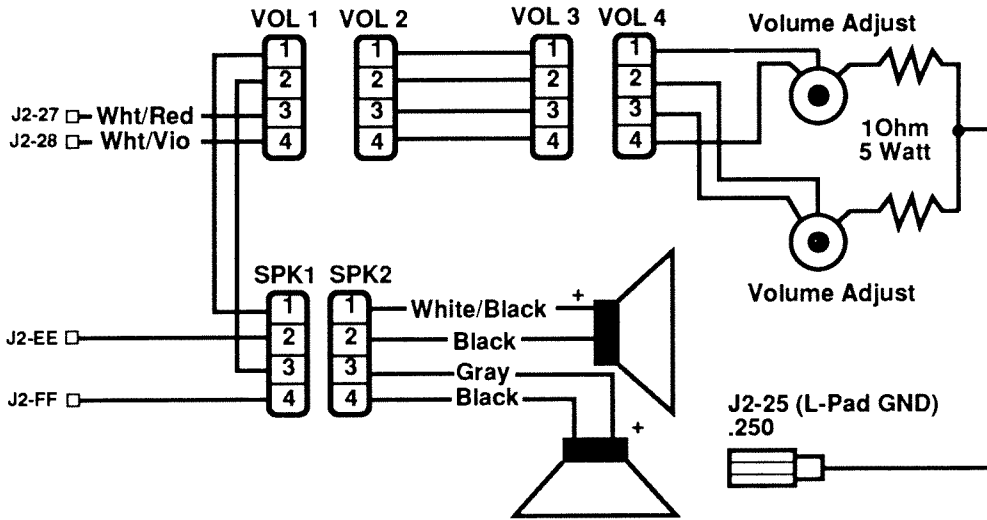

Wiring Diagrams

-DC Power

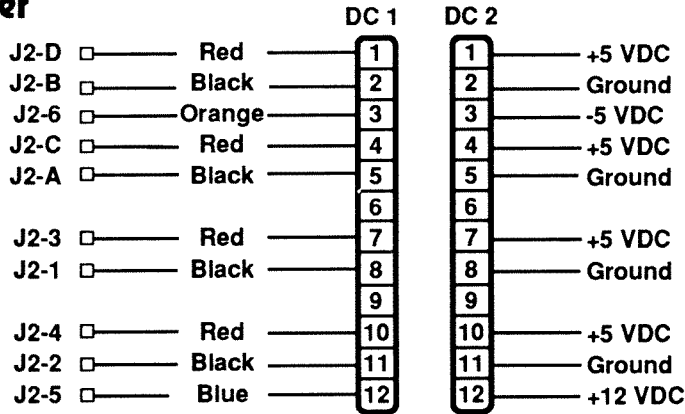

-Video

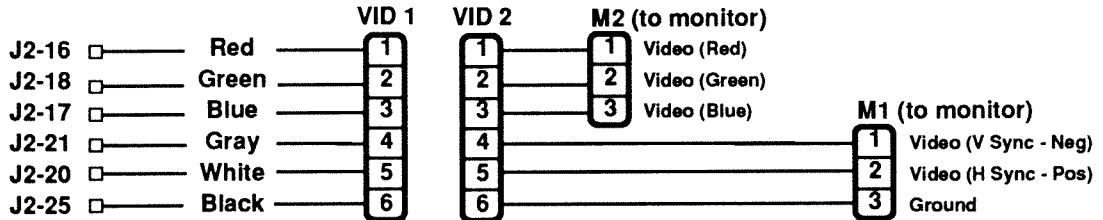

-Coin, Service Switches

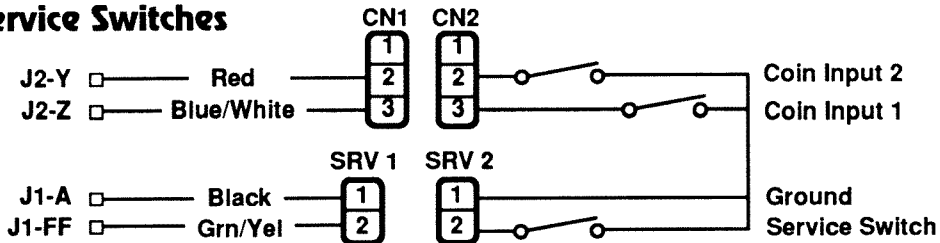

Wiring Diagrams—Player Controls

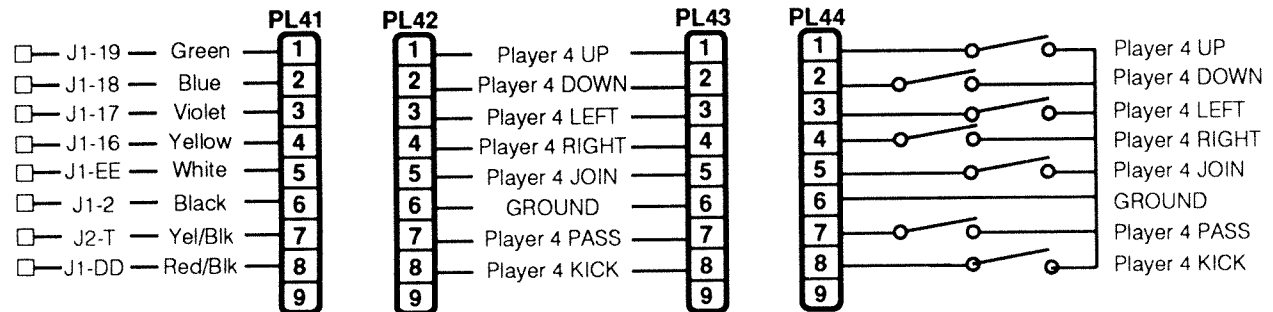
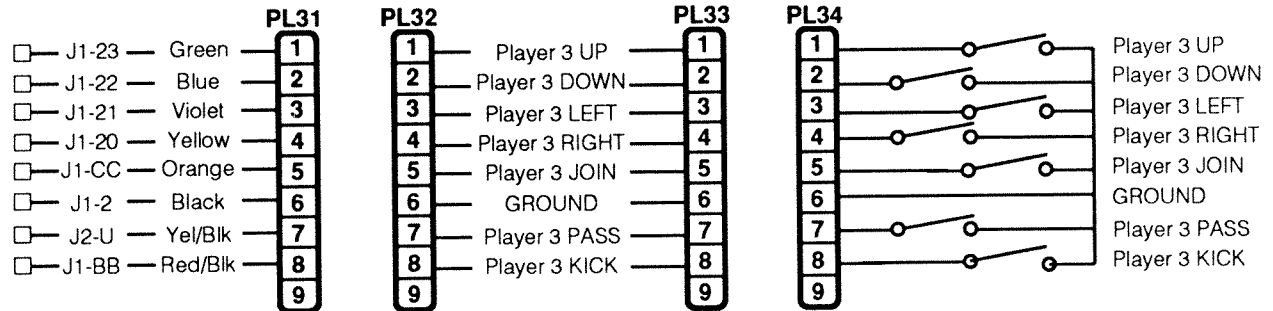
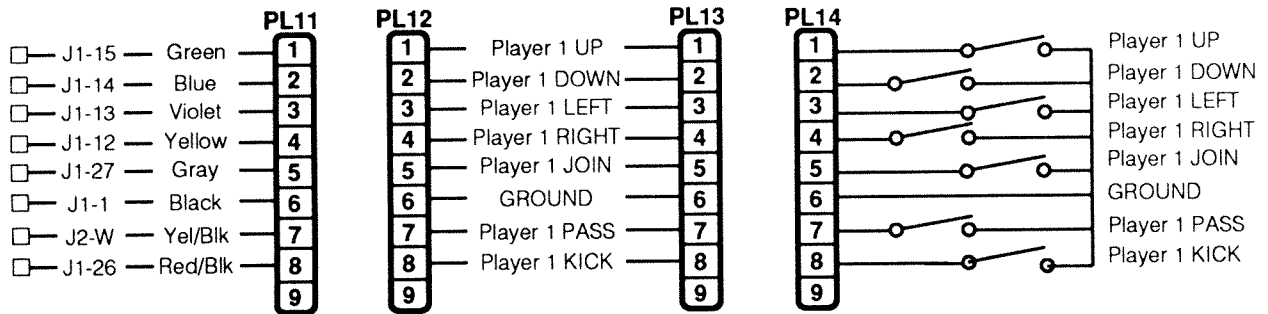
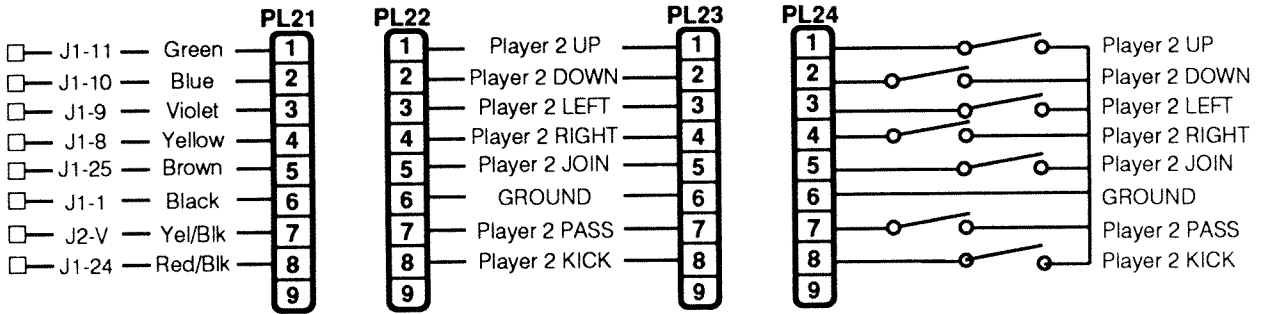

Illustrated Parts List

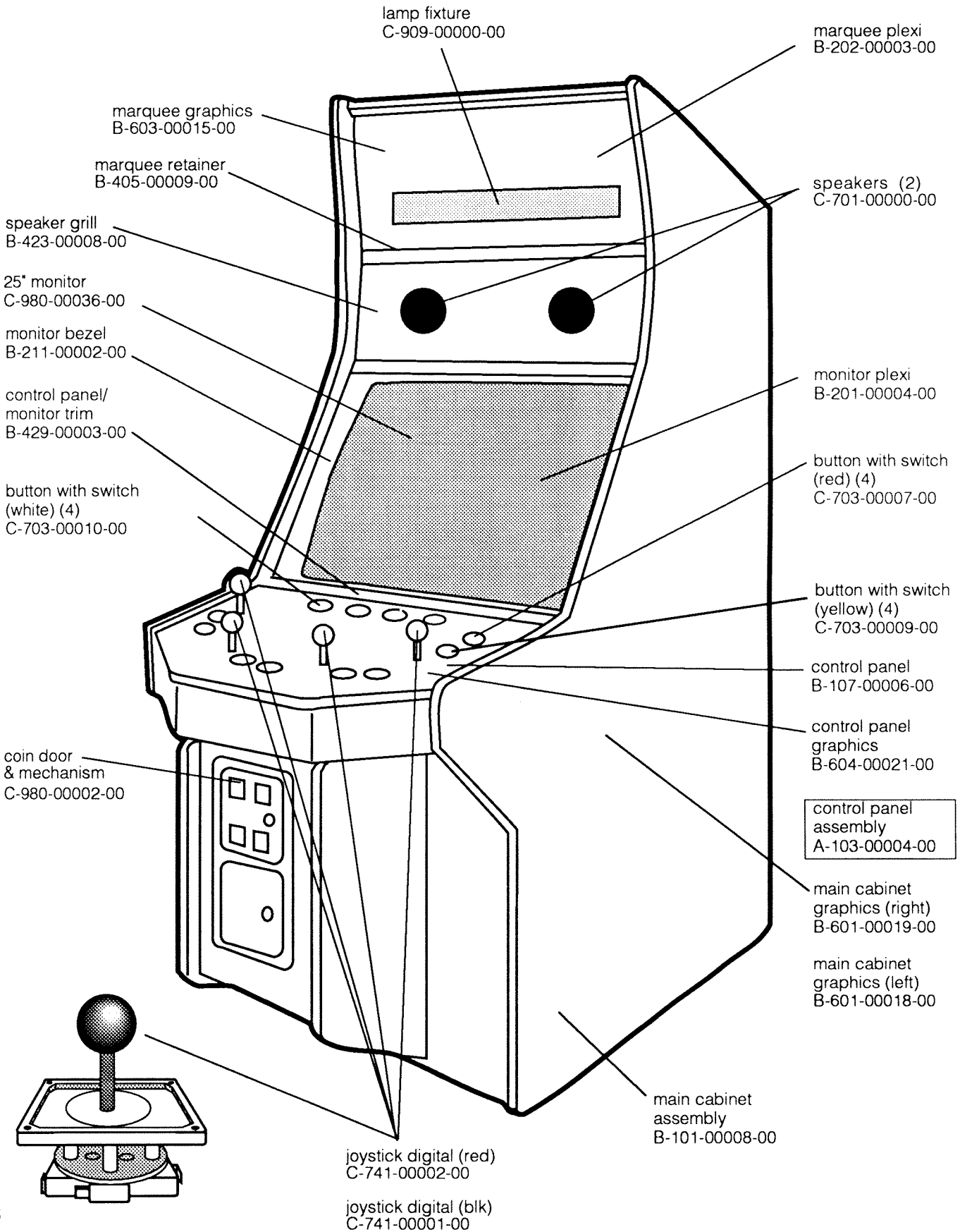

Illustrated Parts List (continued)

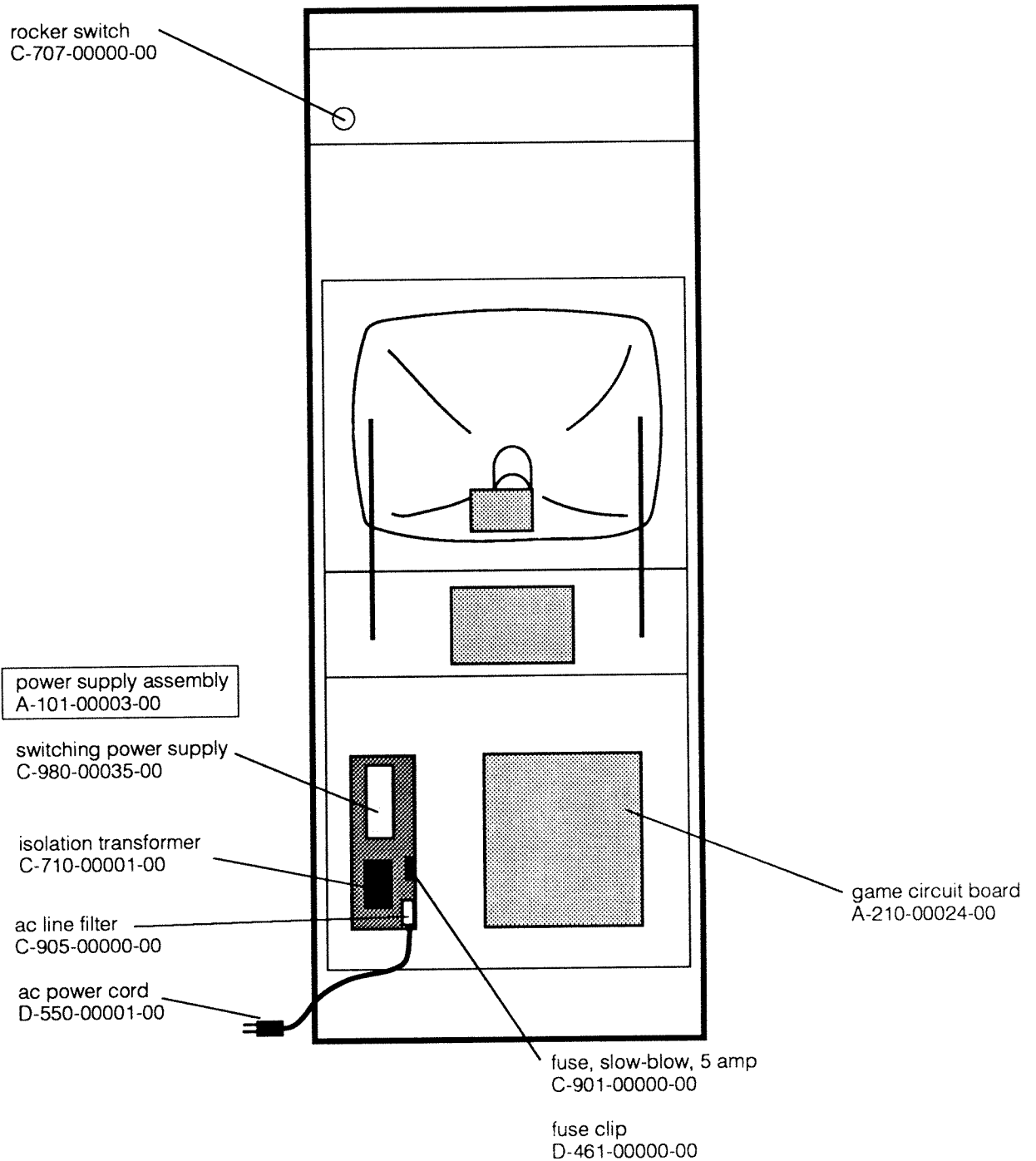

Other Parts

power supply gnd harness
A-301-00020-00

monitor gnd harness
A-301-00027-00

ac power harness
A-301-00086-00

dc power harness
A-301-00100-00

frame gnd harness
A-301-00090-00

control panel harness player 1
A-301-00081-00

control panel harness player 2
A-301-00082-00

control panel harness player 3
A-301-00084-00

control panel harness player 4
A-301-00083-00

circuit board harness
A-301-00102-00

main harness
A-301-00089-00

video harness
A-301-00101-00

The Leland Corporation Warranty

The Leland Corporation warrants that whenever the power supply and/or the printed circuit boards and/or all parts contained therein are furnished with its product, that such part or parts will be free from all defects in materials and workmanship for a period of sixty (60) days from the date of shipment. The Leland Corporation's warranty of above parts is subject to the normal use and service of its product. No other products or parts thereof are warranted. If the products described in this manual fail to conform to this warranty, The Leland Corporation's sole liability shall be, as mutually agreed, to replace or repair such products which are returned to The Leland Corporation during stated warranty period, provided:

- A. The Leland Corporation is notified **in writing** upon discovery by the buyer that said products are defective.
- B. The defective product or part is returned **pre-paid** to The Leland Corporation's plant with a Leland Corp. Returned Merchandise Authorization (RMA) number clearly visible on the outside of the package.
- C. The Leland Corporation's examination of the returned product(s) or part(s) determines, to our satisfaction, that the alleged defects existed and were not caused by accident, misuse, neglect, alteration, improper repair, installation, or testing.

The Leland Corporation is not responsible for bent pins on ICs not installed by our employees. In no event shall The Leland Corporation be liable for loss of profits, loss of use, or incidental or consequential damages.

EXCEPT FOR THIS WARRANTY, THE LELAND CORPORATION DISCLAIMS ALL OTHER WARRANTIES, EXPRESSED OR IMPLIED, INCLUDING THE IMPLIED WARRANTIES OF MERCHANTABILITY AND FITNESS FOR A PARTICULAR PURPOSE, AND ALL OTHER OBLIGATIONS OR LIABILITIES ON THE LELAND CORPORATION'S BEHALF, AND IT NEITHER ASSUMES NOR AUTHORIZES ANY OTHER PERSON TO ASSUME FOR THE LELAND CORPORATION ANY OTHER LIABILITIES IN CONNECTION WITH THE SALE OF PRODUCTS MANUFACTURED BY THE LELAND CORPORATION.

The Leland Corporation
1841 Friendship Drive
El Cajon, CA 92020
(619) 562-7000

ADDENDUM

5-24-90

WORLD SOCCER FINALS

Manual Part Number B-701-00015-00 Rev. A

THE CORRECT POWER SUPPLY VOLTAGES FOR CONNECTOR J2 ARE
PIN 5 = -5VDC, (BLUE), PIN 6 = +12VDC (ORANGE).

ON PAGE 23 AND 24 THE VOLTAGE INDICATIONS ARE REVERSED,
THE WIRE COLOR AND CONNECTIONS SHOWN ARE CORRECT.

ON PAGE 19 THE BLUE AND ORANGE COLOR LABELS SHOULD BE
EXCHANGED ON THE WIRES BETWEEN THE POWER SUPPLY AND
CONNECTOR DC2, (-5 AND +12VDC).

THE INDICATED WIRING AND FUNCTIONS ARE CORRECT, ONLY
THESE TWO COLORS ARE EXCHANGED.

IN THE MICROPROCESSOR DIAGNOSTIC SCREENS THE FOLLOWING
SUBSTITUTIONS APPLY;

<i>SCREEN SAYS</i>	<i>SHOULD BE</i>
U75x	U159
SRAM LO NIBBLE	U63
U51	U57 OR U87
U50	U78
GRAM LOW LOWER	U143
GRAM LOW UPPER	U144
GRAM HIGH LOWER	U143
GRAM HIGH UPPER	U144
U135	U3
U136	U4
U137	U5
U138	U6
EVEN RAM CHIP	U7
ODD RAM CHIP	U2

THANK YOU

The Leland Corporation

1841 Friendship Dr., El Cajon, CA 92020-9981
619-562-7000 Telex-497293 Fax-619-562-9468