

CAPCOM



KIT INSTRUCTION MANUAL

WARNING

**THIS GAME MUST BE GROUNDED. FAILURE TO DO SO MAY
RESULT IN DESTRUCTION TO ELECTRONIC COMPONENTS.**

WARNING: This equipment generates, uses and can radiate radio frequency energy and if not used in accordance with the instruction manual, may cause interference to radio communications. It has been tested and found to comply with the limits for a CLASS A computing device pursuant to SUBPART J and PART 15 of FCC RULES, which are designed to provide reasonable protection against such interference when operated in a commercial environment. Operation of this equipment in a residential area is likely to cause interference in which case the user at his own expense will be required to take whatever measures may be required to correct the interference.

CAPCOM, USA INC.

INVITES YOU TO USE

*OUR TOLL FREE NUMBER FOR
SERVICE INFORMATION CONCERNING THIS GAME, OR ANY
OTHER CAPCOM GAME YOU NOW HAVE ON LOCATION.
PLEASE HAVE GAME SERIAL NUMBERS AND CABINET NUMBERS READY.*

*CALL US FOR PROMPT, COURTEOUS
ANSWERS TO YOUR PROBLEMS.*

California Only	(800) 222-0928
Continental U.S.	(800) 843-4632
Direct Number	(408) 727-0400

WARRANTY, REPAIR AND RETURN POLICY

REPLACEMENT PARTS:

CAPCOM USA maintains a stock of replacement parts for our products. When placing an order for parts, please supply a complete description of the item, quantity required, P.O. number, and shipping information. We attempt to ship orders the day they are received, orders received after 12:00 noon will ship the following work day. We do not have a minimum order requirement at this time, however we certainly appreciate your efforts to consolidate your orders whenever possible.

Payment Terms are NET 30.

RETURN MATERIAL AUTHORIZATIONS:

Material can be returned to CAPCOM USA only in the following situations:

1. Parts, return for credit. A parts order was processed incorrectly, ie; wrong items were shipped, wrong quantity was shipped, etc.
2. PCB, Repair & Return. A PCB requires repair by CAPCOM USA's technical staff.
3. PCB, Return for Credit. A PCB is being returned for credit to satisfy an Advance Exchange transaction.
4. Other, parts are being returned for engineering analysis, etc., only with prior consent of Customer Service or Sales department.

To obtain a Return Material Authorization, please contact CAPCOM USA's Customer Service department. Describe the transaction and request an RMA number. The outside of the package must be clearly marked with the RMA number. Packages not displaying an RMA number will be returned un-opened.

REPAIR & RETURN PCBs:

CAPCOM USA staffs qualified technicians to assist your repair department. In the event you have a CAPCOM USA PCB that is out of warranty and requires repair, we can provide repair services to you. When requesting an RMA number for a Repair & Return, indicate the type of PCB being returned for repair, P.O. number, and shipping information.

Repairs will be processed within 1 working day of receipt of defective item. Labor charges are \$40.00 per hour plus parts. If the initial estimate indicates that the labor will exceed 1 hour, our technicians will call and request authorization to continue the repair.

Payment Terms are NET 30.

WARRANTY REPAIRS:

During the initial 90-day warranty, customers who's accounts are current are eligible for an Advance Exchange PCB. When calling for an Advance Exchange PCB, please supply a complete description of the item needed, game serial number for warranty verification, P.O. number, and shipping information. You will be issued an RMA number for the return of the defective PCB.

Terms for Advance Exchanges are NET 15. If the defective PCB is not returned within 30 days, no additional Advance Exchanges will be issued until the offending PCB is returned, or the invoice is paid in full. If the PCB is not returned until after 90 days, the warranty will be voided, and the customer will be liable for all repair charges.

It is our goal to constantly improve and better our services to you. Your cooperation with the above stated policies will help us greatly to reach this goal. If you have any comments or questions, please telephone our Customer Service department. We will make every attempt to tailor our services accordingly.

Before You Get Started...Stop!

1. Does your **new game** package include all listed parts? (Is it complete?)
2. Is the game you have chosen to transform able to supply all the required voltages for the **new game**?

Note: Some games, (i.e. Ms. Pac Man, Galaxian, etc.) regulate their voltages on the main P.C.B. This makes the existing power supply inefficient. These games will require a change in power supply for your **new game**. Many game supply houses can offer you a switching regulated power supply for a relatively low cost.

3. Is the monitor configuration compatible? In most games it is rather difficult to change the monitor from a vertical mount to a horizontal mount. We recommend you choose a game cabinet with the same mount as your **new game** requires.
4. Do you have the necessary tools? (See the recommended tool list)

Installing and Servicing Your

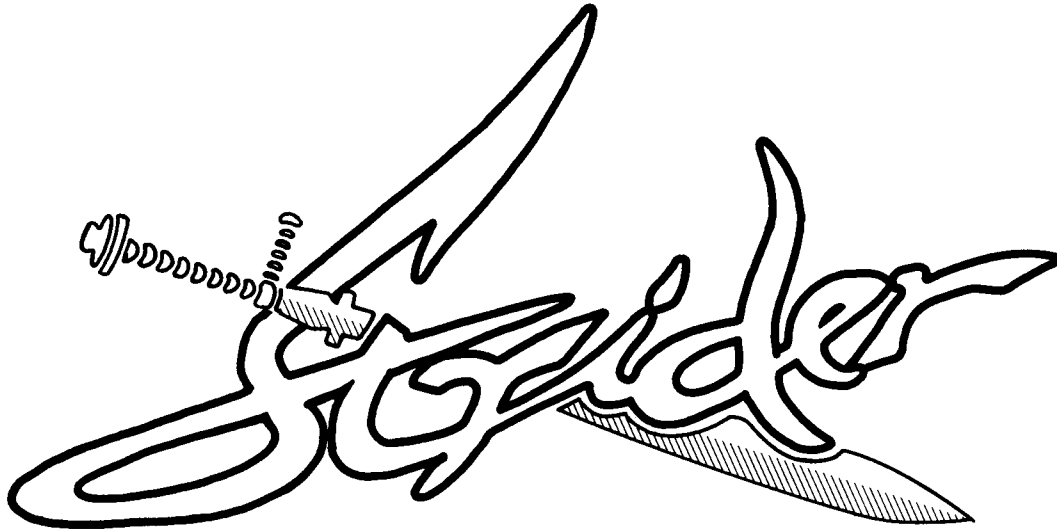

New Game Package

Table of Contents

Power and Monitor Requirements.....	2
New Game Package Contents.....	2
Recommended Tools and Supplies.....	3
Dip Switch Tables.....	3, 4
Game Description.....	5
Installation Procedures.....	6
Helpful Hints.....	12
Control Panel Positioning.....	13
Main Harness Connections.....	14
Warranty Registration Card.....	15

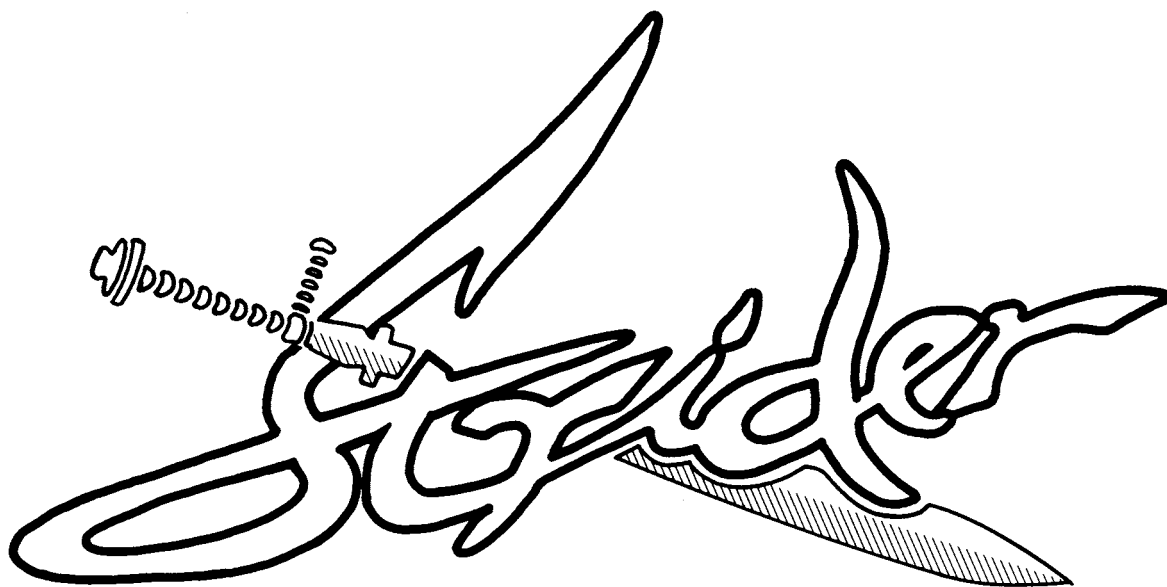

POWER REQUIREMENTS		MONITOR REQUIREMENTS
+5 VDC +12 VDC	7 amp 1 amp	Horizontal Mount Raster Scan Negative Composite Sync

NEW GAME PACKAGE CONTENTS

1 Main Printed Circuit Board (PCB)	1 Control Panel Overlay
1 Set Legs, Bolts, & Spacers	1 Plex Control Cover
1 Connecting Wire Harness	1 Set Side Graphics
1 Eight-Way Joystick	1 Monitor Card
6 Player Button Assemblies	1 Service and Installation Manual
1 Marquee	

Note: Replacement accessories available through your exclusive **Capcom** distributor

Recommended Tools and Supplies

CAPCOM new game package.

Phillips and Slot Screwdrivers
Socket Set
Wire Cutters and Strippers
Pliers or Channel Locks
Planning and Careful Thought
Electric Drill
 $\frac{3}{32}$ ", $\frac{1}{4}$ ", $\frac{7}{16}$ " Drill Bits
 $\frac{1}{4}$ " Plex Bit
 $\frac{13}{16}$ " Chassis or Sheet Metal Punch
 $1\frac{1}{4}$ " Plex Hole Saw
Glass of Water and a Snack
Small File
Razor Knife and Sharp Blades
Straight Edge

Painting Supplies
(if you do your own painting)
Paint Brush and Paint
(don't forget the primer)
Paint Roller and Pan
Sand Paper
Putty Knife and Wood Putty
Staple Gun and Staples
Soldering Iron and 60/40 **Resin Core** Solder
Vacuum Cleaner
Assorted Fastening Hardware
Shrink Tubing: $\frac{3}{32}$ ", $\frac{1}{8}$ ", $\frac{3}{16}$ "
Masking Tape
 $3\frac{1}{2}$ " OR 4" Wire Ties
Spray Window Cleaner and Rags
(baby diapers work GREAT!)

Dip Switch Tables

Optimize Your Profits

Thorough Research shows that two and a half minute games both satisfy players and also keep the quarters flowing.

If games aren't running about two and a half minutes long, then collections probably aren't at their peak. You'll want to tailor your game to your location. The trick is to add just a few DIP switches. (See the chart in this book.) It's easy!

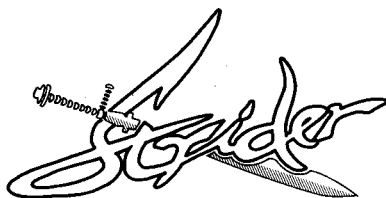

DIP SW (A)

ITEM	DESCRIPTION	1	2	3	4	5	6	7	8
COIN 1	* 1 COIN 1 CREDIT	OFF	OFF	OFF					
	1 COIN 2 CREDIT	ON	OFF	OFF					
	1 COIN 3 CREDIT	OFF	ON	OFF					
	1 COIN 4 CREDIT	ON	ON	OFF					
	1 COIN 6 CREDIT	OFF	OFF	ON					
	2 COIN 1 CREDIT	ON	OFF	ON					
	3 COIN 1 CREDIT	OFF	ON	ON					
COIN 2	* 4 COIN 1 CREDIT	ON	ON	ON					
	1 COIN 1 CREDIT				OFF	OFF	OFF		
	1 COIN 2 CREDIT				ON	OFF	OFF		
	1 COIN 3 CREDIT				OFF	ON	OFF		
	1 COIN 4 CREDIT				ON	ON	OFF		
	1 COIN 6 CREDIT				OFF	OFF	ON		
	2 COIN 1 CREDIT				ON	OFF	ON		
3 COIN 1 CREDIT				OFF	ON	ON			
4 COIN 1 CREDIT				ON	ON	ON			

Computer aided difficulty adjustment.

Strider contains 16 internal level settings. 1 being most easy and 16 being most difficult. 8 external adjustable difficulty settings set the internal automatic adjustments. Example: Very easy external starts at level 3. If player is still playing after 1 minute, 30 seconds, internal difficulty is raised to level 4 and increases every 10 seconds. If player dies before 1 minute, 30 seconds; level is automatically dropped to internal difficulty setting 2. Goes then for 1 minute, 30 seconds, then raises to internal setting 3 again.

DIP SW (B)

ITEM	DESCRIPTION	1	2	3	4	5	6	7	8
DIFFICULTY	VERY EASY	A ON	ON	OFF	Starts at level 3+ 1 min, 30 sec, then every 10 sec. Starts at level 3+ 1 min, then every 15 sec. Starts at level 6+ 1 min, 30 sec, then every 10 sec. Starts at level 6+ 1 min, then every 15 sec. Starts at level 6+ 1 min, then every 10 sec. Starts at level 6+ 45 sec, then every 15 sec. Starts at level 9+ 1 min, then every 10 sec. Starts at level 9+ 45 sec, then every 15 sec.				
		B OFF	ON	OFF					
		C ON	OFF	OFF					
		D OFF	OFF	OFF					
		E OFF	OFF	ON					
		F ON	OFF	ON					
		G OFF	ON	ON					
		H ON	ON	ON					
2 COINS/PLAY	NO				OFF				
1 COIN CONTINUE	YES				ON				
BONUS (EXTEND)	*(A)					OFF	OFF		
	(B)					ON	OFF		
	(C)					OFF	ON		
	(D)					ON	ON		

*(A) 30,000, 60,000, EVERY 70,000 (B) 10,000, 30,000, EVERY 30,000
(C) 20,000, 50,000, EVERY 70,000 (D) 40,000, 70,000, EVERY 80,000

DIP SW (C)

ITEM	DESCRIPTION	1	2	3	4	5	6	7	8
NUMBER OF PLAYER	* 3	OFF	OFF						
	4	ON	OFF						
	5	OFF	ON						
	6	ON	ON						
SCREEN	NORMAL					OFF			
	FLIP					ON			
FREE PLAY	* NO				OFF				
	YES				ON				
SCREEN STOP	* NO			OFF					
	YES			ON					
SOUND DURING DEMONSTRATION	* YES						OFF		
	NO						ON		
CONTINUE	* YES							OFF	
	NO							ON	
TEST MODE	* GAME MODE								OFF
	TEST MODE								ON

*RECOMMENDED SETTING "B"

*FACTORY SETTING



Master the Art of Ninjutsu with Capcom's new smash hit, STRIDER. You control the action of this futuristic Ninja from the year 2048 A.D. as he battles his way from the rooftops of Moscow through the jungles of the Amazon to the skies over planet Earth. Strider, with his totally unique acrobatic flips, incredible climbing ability, and amazing gameplay, will keep your players filling the cashbox. And the graphics are so sharp and colorful, you'll think you're watching an animated cartoon! This is no ordinary video game, and Strider is no ordinary hero. Try STRIDER yourself and discover if you have what it takes to be the Master of Ninjutsu!

Installation Procedures

Something to Think About

Your final product will be a **new game**.

You have made a wise decision to transform a game that has seen better days in the all important cash box into a **new game**. This is by far the most cost effective alternative to maximize the return of your initial investment. All you provide is the cabinet with a power supply and a monitor. Oh yes, you will need a touch of elbow grease. And that's it! We provide the rest. The end result is . . . a **new game** at a very low cost.

Fact: Spend a little time on the cabinet's appearance (i.e. marquee, control panel, and cabinet graphics). With a little paint, some wood putty and new lights, you will raise the profits of any game . . . especially with the introduction of a **new game** package.

The **new game** look should always apply to the inside of your game as well as the outside. A few wire ties and shrink tubing on your harness; some fastening hardware on your subassemblies and a sweep with the ol' vacuum cleaner will ensure that unnecessary *glitches* do not occur.

Remember: You are creating a **new game**.

If you have any questions or just need some advice on any of your **new game** transformations, don't hesitate in giving a member of our technical staff a call.

Let's Get Our Hands Dirty

Preparing the Original Game for the New Game

Remove the following:

1. Main Logic Board(s)
2. Control Panel
3. Monitor Plexiglass
4. Monitor Bezel
5. Marquee
6. Graphics

I would recommend painting your cabinet to give it a fresh new look. (If it is geographically inconvenient to make use of our facilities, you may consider having an auto body shop take care of your painting needs.)

If your cabinet has wood grain sides; remove old graphics and adhesive (adhesive may be removed with **lacquer** thinner.

If you intend to use your original plexiglass, be sure it is in mint condition or it should be replaced.

Thoroughly clean out your cabinet.

Time to Install Your New Goodies

Before You Start . . . Remember DO NOT Do this Work with the Power On!

Logic P.C.B. Cage

Mount the logic cage securely (away from power supply).

- A Mark and drill pilot holes ($3/32''$).
- B Place the logic cage (bottom) over the holes and secure it with the supplied wood screws.
- C Install the P.C.B. into the logic cage. Use feet and spacers supplied and adjust them so that the screws will go through the slots in the cage bottom.

Note: Leave the cage cover off until you have attached the entire wire harness and have tested the game for proper operation.

Wire Harness

Attach the wire harness connector to the main logic board. **CAUTION:** Sometimes the connector is not keyed and it is very easy to install it reversed on the logic board. Even if it is keyed, always **triple check** to be sure the wire inputs were connected correctly to the connector and the connector to the logic board.

Connecting the Wire Harness to the Existing Wires

When you hook up the control panel, power supply, monitor or other subassemblies that remain in the game cabinet to your new wire harness, try and use their existing secondary connectors.

1. Cut the original wire approximately three inches from the original connector. Strip off about one half inch of insulation.
2. Solder the new wire designated for that position to the original wire you just stripped.

Warning: DO NOT JUST TIE THE WIRES TOGETHER. THIS CAN CAUSE NAGGING INTERMITTENT PROBLEMS THROUGH LOOSE CONNECTIONS OR OXIDATION OR BOTH. **Always take the time to do it right.**

3. Melt shrink tubing around all your in-line wire connections. Do not use electrical tape. Tape could unravel over a period of time due to the cabinet heat and cause you a great deal of trouble.
4. Use wire tie wraps, and secure the cable to the cabinet whenever it seems necessary. Remember this is a **new game**, not a sloppy conversion.

Power Wires

1. Connect the wires that are designated for your power supply. You will need a supply of +5V, +12V & ground. Your **new game** package may not require all of the voltages that were used in the original game. Tie off any unused wires.
2. You will notice that you probably have more than one wire for each voltage. It is a good idea to use all wires supplied (double up if it is necessary). This will help to ensure that you don't overload the edge connector pins and cause them to "burn".

Monitor Wires

You will be connecting the wires designated for the RED, GREEN & BLUE video guns along with the SYNC & GROUND wires.

NOTE: . . . CONCERNING SYNC:

Your **new game** only calls for one sync wire connection, this is called **composite sync** (horizontal and vertical tied together). This composite sync is also **negative**. Most monitors have supply positions for both negative and positive sync. You can check your monitor manual or call our technical department for assistance.

Speaker Wires

Find the two wires that are designated for the speaker and hook 'em on up.

Coin Door Wires

1. Connect the designated wires to the coin switches and meter.
2. You can connect your door lamps to the unused $-5V$ power supply. Some games have separate power outputs for the coin door lamps.
3. Be sure to clean and lubricate your old coin mechanisms. Keep the money coming in.

Guess What?

You are almost done with the electrical connections of your **new game**. All you have left is the control panel wiring. But we are going to hold off on that for right now. We have a few other things we need to do first. So why don't you go ahead and get yourself a drink of water and stretch your legs. When you return, we can take a fresh look at your progress and then move forward.

Smoke Test

What Test?

Don't worry. All this means is that you are ready to apply power to the system for the first time and you pray that there will be no smoke from a simple oversight.

You are just about ready to power up the logic board. But first we need to recheck your work.

1. Carefully inspect the game for loose power wires, exposed connections and extra fastening hardware.
2. Make sure the logic board, board cage, monitor, and power supply are securely fastened in place.
3. **Double check** the connectors to be sure they are wired and connected properly.
4. Set the dip switches on the logic board to the factory recommendations.

Time to Apply Power:

1. Look and smell for smoke. (TURN OFF IMMEDIATELY IF ANY IS NOTICED)
2. Listen for game sounds.

If after one minute you have not heard any sounds:

- A) Check for proper dip switch settings.
- B) Adjust volume control and check speaker connections.
- C) Check the +12V power supply to the logic board.

NOTE: If you do get sounds, but they are a little fuzzy, switch the wires around on the speaker. See page 12 for more helpful hints.

3. How is the monitor image?

A) Is the picture in sync?

If your picture has the top and bottom halves of the screen reversed and it will not stop rolling, change your sync polarity on the monitor. (Positive to negative).

If your monitor does not have dual polarity positions for sync, then you will need to reverse the sync yourself by installing a simple one I.C. circuit between the logic board and the monitor. (The following illustration shows a hookup for both **composite** and **separate** syncs.

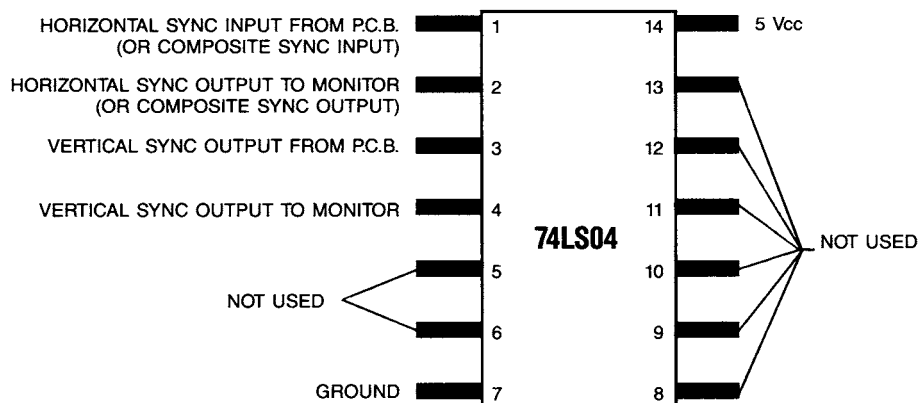

G07 MONITOR SYNC MODE

1. Replace R314 from 390Ω to 1.8KΩ resistor
2. Replace C303 from .1μf 35V cap, locate “+” side of cap to emitter of X305
3. Replace C501 with .1μf (old C303)

B) Now how's your picture?

- Is it centered?
- Is it too bright or dim?
- Is it in focus?

Check your monitor manual for these adjustments. If your screen looks “off”, then your **new game** transformation may have been in vain. So let's take the time to make the monitor look great.

C) Is the picture upside-down?

Dip switch 5 on switch bank “C” should solve your problems.

Control Panel Assembly

1. Remove the buttons, joysticks and wire harness and put them aside for now. Do not remove the original panel overlay until the new holes have been drilled.
2. Mark positions on the panel for the new holes.
CAPCOM supplies a clear 1/8" thick of plexiglass with every **new game** package to convert the control panel. We feel that your **new game** investment is well worth protecting. . .and the control panel is the first place to show wear and tear.
 - You will need to cut this piece to size. Use the control panel as a template.
 - Use a razor knife to score the plexiglass **deeply**. Then use a pair of pliers to break away the extra plexiglass.
3. Now drill the holes in your panel that you have marked off for the *buttons*, *joystick* and *bolts*.
4. Drill the same holes on your plexiglass panel protector. Once again use your panel as a template.
Hint: To avoid chipping while you are drilling the holes, place the plexiglass securely on a soft wood surface and use a plexiglass drill bit and hole cutter.
5. The holes are now all cut. Smooth them out on your panel and plexiglass with a fine toothed file.
6. Remove the original graphics overlay from the panel. Clean up the panel and install your **CAPCOM** graphics.
Make It Easier: Peel the top half of the protective backing off of your graphics. Start from the center and smooth out your overlay. Make sure you have about an inch extra coming off the top. *No bubbles please*. Now peel off the bottom half and do the same as you did for the top.
7. Adhere the instruction and function labels.
8. Install the Plex Control Cover over your completed **new game** panel.
Note: Be sure to bolt the plexiglass securely to the panel.
9. Mount the joystick and the buttons to the panel and wire them up. (Use the existing Panel wiring if possible)

Marquee Installation

Using the original marquee as a template, Center your **new game** marquee graphics and score the new marquee deeply to fit the cabinet. Break off the excess with pliers.

Be sure the light behind the marquee works. Everything should **always work** on a new game.

Take your time. . .Don't forget this is going to be a **new game**.

Side Graphic Installation

1. Be sure sides of game are clean and free of old adhesive, dust, etc.
2. Mark position of decal with erasable pen or pencil (centered on upper half of cabinet).
3. Peel off top 1/4" of decal backing and apply to cabinet with a smoothing motion (use a soft rag). Continue peeling off backing and smoothing.
4. Remove any small bubbles with a pin or razor blade (pop them!)

Finishing Touches

1. Check the game inside and out for any imperfections. Secure any loose wiring or fastening hardware.
2. Make sure the coin door is tight and the coin mechs are well adjusted. A game is no good to anybody if you can't get a coin into it.
3. Once again go over every step of this **new game** transformation in your mind. Be sure everything is correct and to your liking.
4. Power up the game.
 - A. Check all the coin switches. (Does the coin meter work?)
 - B. Play your **new game**.
 - Are all the player controls working?
 - Are the game sounds present?
 - Is the volume level proper?
 - Are the dip switches set properly?

Well, that's about it. Good Luck.

Helpful Hints

Simple audio check for Board: TYPICAL AUDIO CIRCUIT FOR CAPCOM BOARD:

CONNECT EARPHONE BETWEEN POINT "A" & GROUND. AUDIO FROM CPU BOARD SHOULD BE HEARD.

NEXT CHECK POINT "B" AND GROUND. ADJUST POT FOR LOUDNESS IN EARPHONE.

CHECK POINT "C" & GROUND FOR INPUT AUDIO TO PIN 3 OF HA13001 AUDIO CHIP.

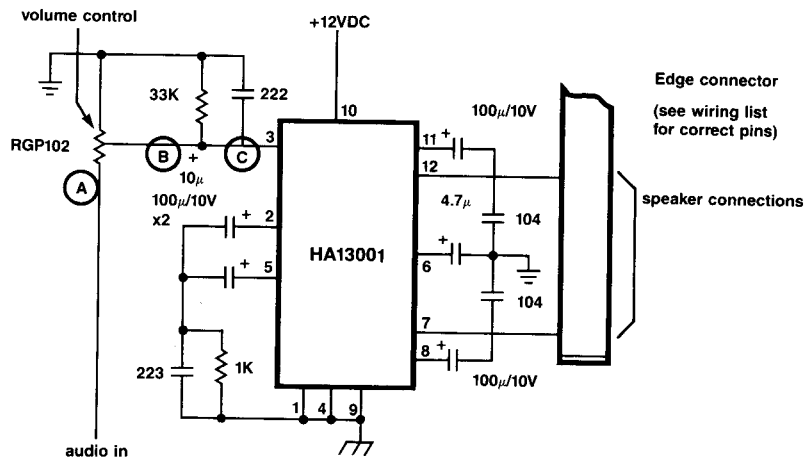

Also make sure Ground from +5VDC and Ground from +12VDC ARE TIED TOGETHER. IF GROUNDS ARE FLOATING, you could have audio problems.

NOTES:

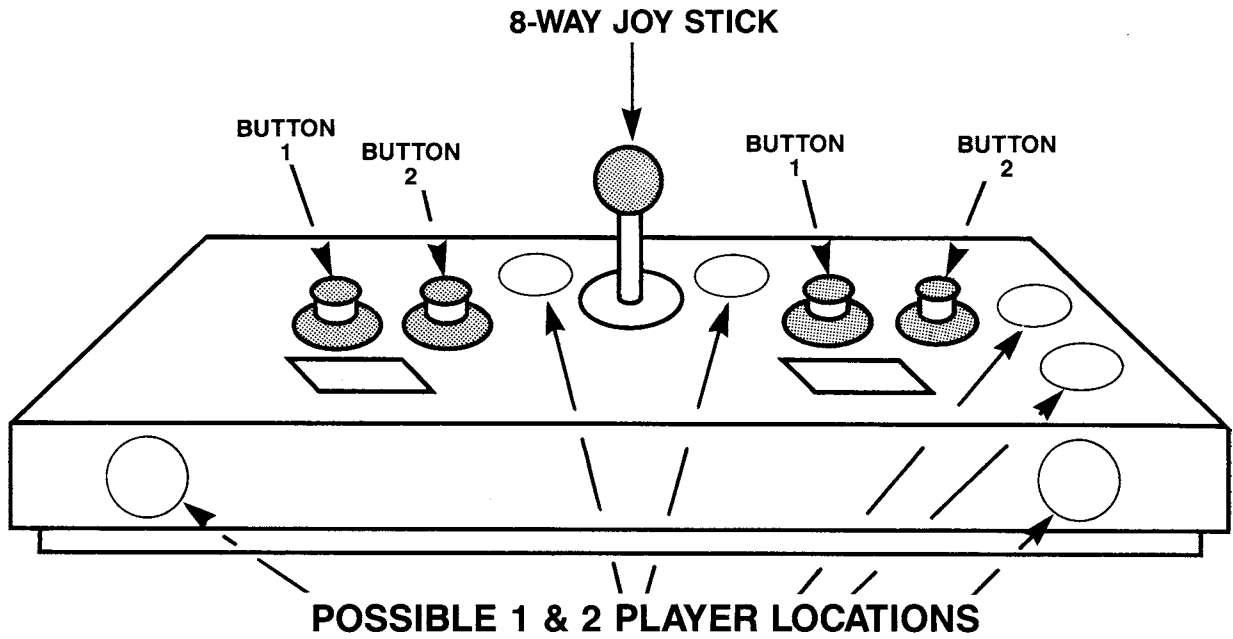

Control Panel Positions

CONTROL PANEL

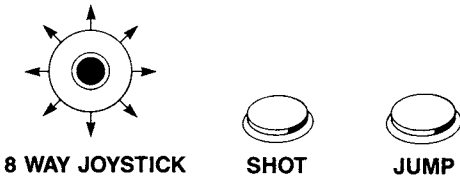

8 WAY JOYSTICK

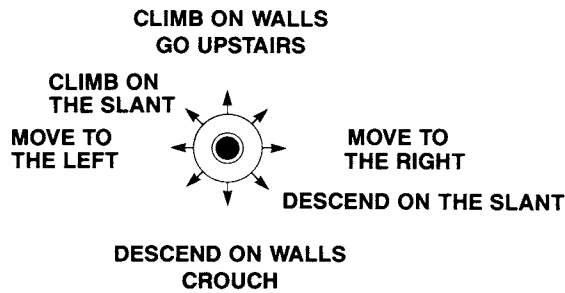

CREDIT LIMITATION AT ONE TIME: 9 CREDITS

POSITION OF DIP SWITCH

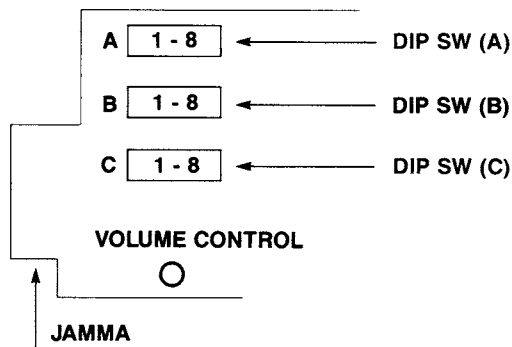

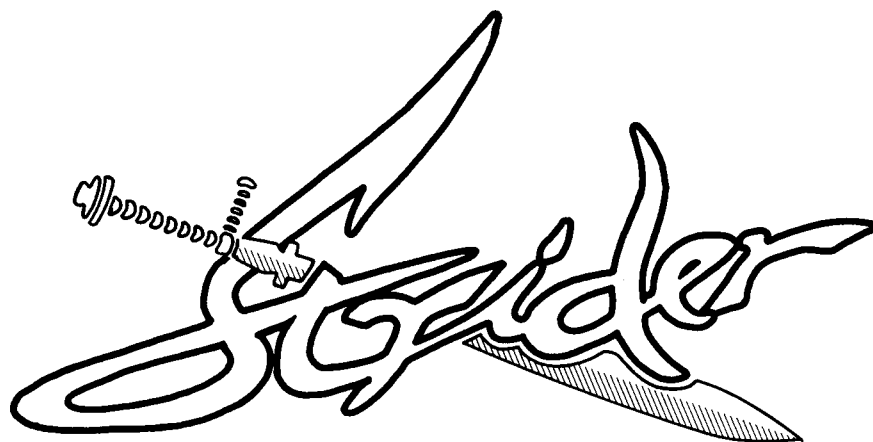

MAIN HARNESS CONNECTIONS

Wire Color	Solder Side			Parts Side	Wire Color
Black	Ground	A	1	Ground	Black
Black	Ground	B	2	Ground	Black
Red	+5VDC	C	3	+5VDC	Red
Red	+5VDC	D	4	+5VDC	Red
White	-5VDC	E	5	-5VDC	White
Yellow	+12VDC	F	6	+12VDC	Yellow
	Key	H	7	Key	
Brown	Counter 2	J	8	Counter 1	Brown
Red	Not Used	K	9	Not Used	Red
Black	Speaker (-)	L	10	Speaker (+)	White
Blue	Not Used	M	11	Not Used	Blue
Green	Video Green	N	12	Video Red	Red
Gray	Video Sync	P	13	Video Blue	Blue
Red	Service SW	R	14	Video Gnd	Black
Brown	Not Used	S	15	Not Used	Brown
White	Coin 2	T	16	Coin 1	White
Gray	2P Select	U	17	1P Select	Gray
Violet	2P Up	V	18	1P Up	Violet
Blue	2P Down	W	19	1P Down	Blue
Green	2P Left	X	20	1P Left	Green
Yellow	2P Right	Y	21	1P Right	Yellow
Orange	2P Button A	Z	22	1P Button A	Orange
Red	2P Button B	a	23	1P Button B	Red
Brown	Not Used	b	24	Not Used	Brown
Blue	Not Used	c	25	Not Used	Blue
Blue	Not Used	d	26	Not Used	Blue
Black	Ground	e	27	Ground	Black
Black	Ground	f	28	Ground	Black

CAPCOM GAME OWNER:

Please fill out card and register for Free drawing at COIN-OP SHOWS.
YOU NEED NOT BE PRESENT TO WIN.

Remember to fill in S/N of PCB (S/N IS REQUIRED FOR DRAWING).

REGISTER FOR FREE DRAWING



-15-

FROM:

PLACE
STAMP
HERE

CAPCOM U.S.A., INC.

COIN-OP DIVISION
3303 Scott Boulevard
Santa Clara, CA 95054

