

AREAS 1™

Operator's Manual



TIME WARNER
INTERACTIVE™



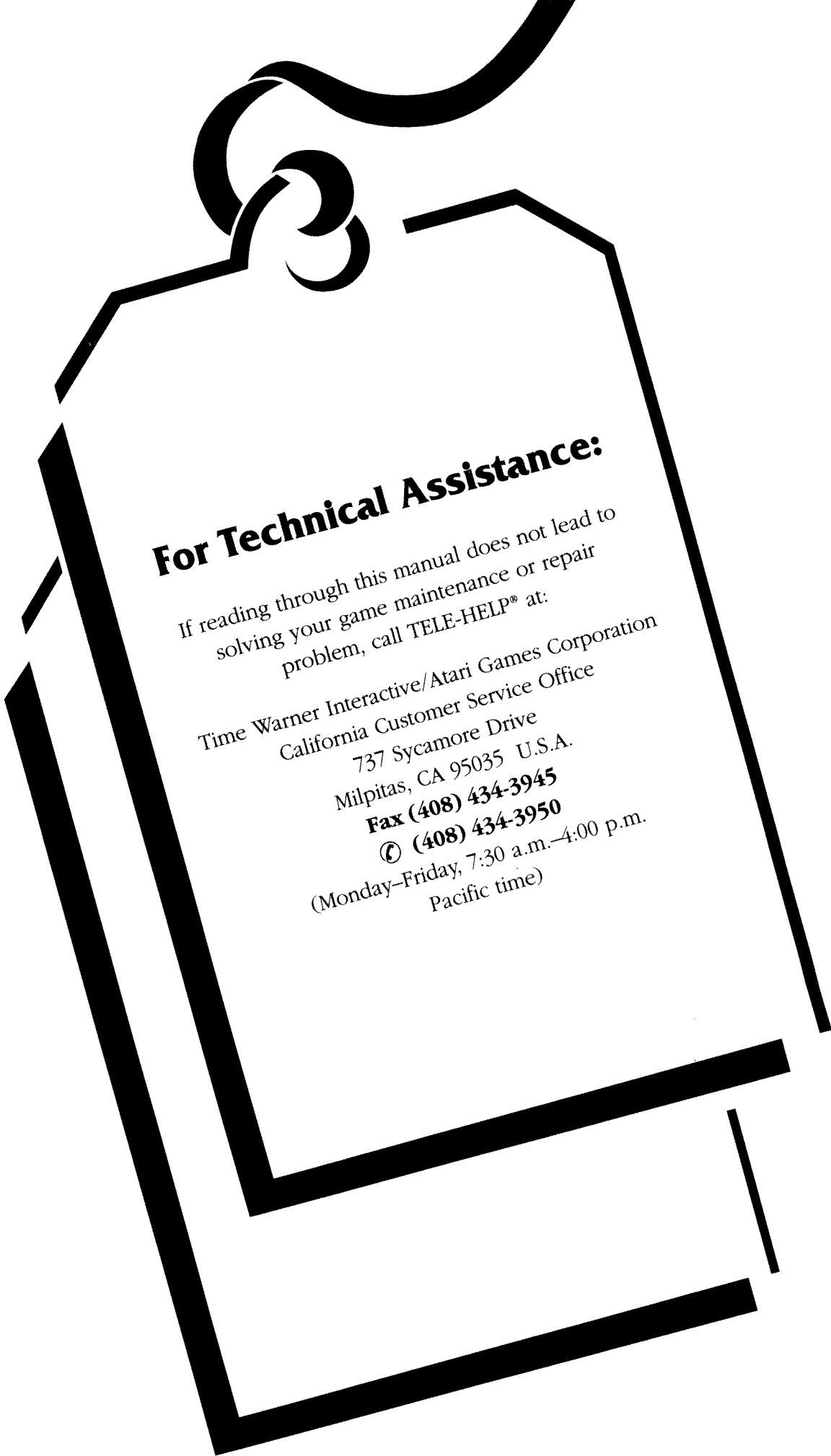

For Technical Assistance:

If reading through this manual does not lead to solving your game maintenance or repair problem, call TELE-HELP® at:

Time Warner Interactive/Atari Games Corporation
California Customer Service Office
737 Sycamore Drive

Milpitas, CA 95035 U.S.A.

Fax (408) 434-3945

☎ (408) 434-3950

(Monday-Friday, 7:30 a.m.-4:00 p.m.
Pacific time)

AREA 51™

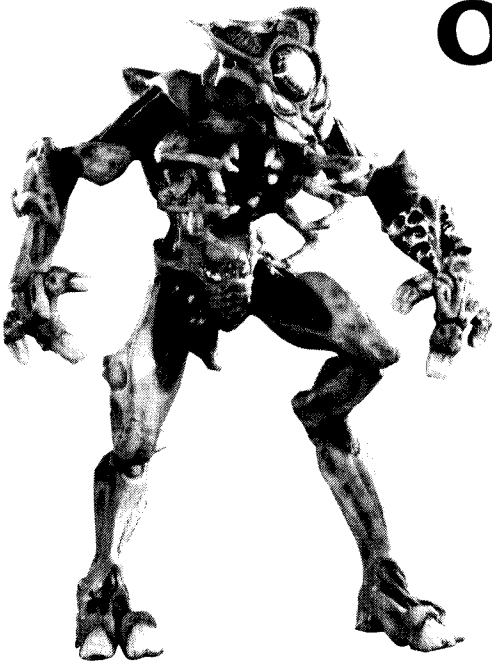

Operator's Manual

with Schematics



TIME WARNER
INTERACTIVE™

COPYRIGHT NOTICE

Copyright © 1995, 1996 by Atari Games Corporation. All rights reserved.

No part of this publication may be reproduced by any mechanical, photographic or electronic process, or in the form of a phonographic recording, nor may it be stored in a retrieval system, transmitted, or otherwise copied for public or private use, without permission from the publisher.

The game play, all graphic designs, this technical manual, its accompanying schematic diagrams, and the display manual are protected by the U.S. Copyright Act of 1976.

This Act provides for substantial penalties for violating federal copyright laws. Courts can impound infringing articles while legal action is pending. If infringers are convicted, courts can order destruction of the infringing articles.

In addition, the Act provides for payment of statutory damages of up to \$50,000 per infringing transaction in certain cases. Infringers may also have to pay costs and attorneys' fees and face an imprisonment of up to five years as well as fines of up to \$250,000 in the case of individuals and up to \$500,000 in the case of corporations.

Atari Games Corporation will aggressively enforce its copyrights against infringers. We will use all legal means to immediately halt any manufacture, distribution, or operation of a copy of video games made by us. Anyone who purchases such copies risks forfeiting such a game.

Published by:
Atari Games Corporation
675 Sycamore Drive
Milpitas, California 95035

Printed in the U.S.A. **1/96**

Produced by the Time Warner Interactive
Technical Publications Department.

Design: Andrea Dencker
Writing and Editing: Ray Munson
Cover: Andrea Dencker and Steve
Caterson



NOTICE RE NON-ATARI® PARTS

WARNING

Use of non-Atari parts or modifications of any Atari game circuitry may adversely affect the safety of your game, and may cause injury to you and your players.

You may void the game warranty (printed on the inside back cover of this manual) if you do any of the following:

- Substitute non-Atari parts in the game.
- Modify or alter any circuits in the game by using kits or parts *not* supplied by Atari Games Corporation.

FCC COMPLIANCE

This equipment generates, uses, and can radiate radio frequency energy, and if not installed and used in accordance with the instruction manual, may cause interference to radio communications. It has been tested and found to comply with the limits for a Class A computing device pursuant to Subpart J of Part 15 of Federal Communications Commission (FCC) Rules, which are designed to provide reasonable protection against such interference when operated in a commercial environment. Operation of this equipment in a residential area or modification to this equipment is likely to cause interference, in which case the user, at his own expense, will be required to take whatever measures may be required to correct the interference. If you suspect interference from an Atari game at your location, check the following:

- All ground wires in the game are properly connected as shown in the game wiring diagram.
- The power cord is properly plugged into a grounded three-wire outlet.
- On games provided with an Electromagnetic Interference (EMI) ground plane, be sure that the game printed-circuit boards (PCBs) are properly installed on the EMI ground plane and that the end board is securely installed with **all** screws in place and tightened.

If you are still unable to solve the interference problem, please contact Customer Service at Atari Games Corporation. See the inside front cover of this manual for service in your area.

SAFETY SUMMARY

The following safety precautions apply to all game operators and service personnel. Specific warnings and cautions will be found in this manual whenever they apply.

WARNING

Properly Ground the Game. Players may receive an electrical shock if this game is not properly grounded! To avoid electrical shock, do not plug in the game until it has been inspected and properly grounded. This game should only be plugged into a grounded three-wire outlet. If you have only a two-wire outlet, we recommend you hire a licensed electrician to install a three-wire grounded outlet.

AC Power Connection. Before you plug in the game, be sure that the game's power supply can accept the AC line voltage in your location. The line voltage requirements are listed in the first chapter of this manual.

Disconnect Power During Repairs. To avoid electrical shock, disconnect the game from the AC power before removing or repairing any part of the game. If you remove or repair the video display, be very careful to avoid electrical shock. High voltages continue to exist even after power is disconnected in the display circuitry and the cathode-ray tubes (CRTs). Do not touch the internal parts of the display with your hands or with metal objects! Always discharge the high voltage from the CRTs before servicing them. Do this after you disconnect them from the power source. First, attach one end of a large, well-insulated, 18-gauge jumper wire to ground. Then momentarily touch the free end of the grounded jumper wire to the CRT anode by sliding the wire under the anode cap. Wait two minutes and do this again.

Use Only Atari Parts. To maintain the safety of your Atari game, use only Atari parts when you repair it. Using non-Atari parts or modifying the game circuitry may be dangerous, and could injure you and your players.

Handle the CRTs With Care. If you drop a CRT and it breaks, it may implode! Shattered glass from the implosion can fly six feet or more.

Use the Proper Fuses. To avoid electrical shock, use replacement fuses which are specified in the parts list for this game. Replacement fuses must match those re-

placed in fuse type, voltage rating, and current rating. In addition, the fuse cover must be in place during game operation.

CAUTION

Handle Disk Drive Unit With Care. Use special care when installing the circuit boards and handling the hard disk drive. Take basic precautions to avoid excessive impact or electrostatic discharges. Attached to the hard disk drive is a shock indicator that detects severe impacts. Do not remove or tamper with this indicator. Thoroughly review the operator's manual and videotape provided with this product.

Properly Attach All Connectors. Make sure that the connectors on each printed circuit board (PCB) are properly plugged in. The connectors are keyed to fit only one way. If they do not slip on easily, do not force them. If you reverse a connector, it may damage your game and void your warranty.

Ensure the Proper AC Line Frequency. Video games manufactured for operation on 60 Hz line power (used in the United States) must not be operated in countries with 50 Hz line power (used in Europe). If a 60 Hz machine operates on 50 Hz line power, the fluorescent line ballast transformer will overheat and cause a potential fire hazard. Check the product identification label on your machine for the line frequency required.

ABOUT NOTES, CAUTIONS, AND WARNINGS

In Atari publications, notes, cautions and warnings have the following meaning:

NOTE — A highlighted piece of information.



CAUTION — Equipment and/or parts can be damaged or destroyed if instructions are not followed. You will void the warranty on Atari printed-circuit boards, parts thereon, and video displays if equipment or parts are damaged or destroyed due to failure of following instructions.



WARNING — Players and/or technicians can be killed or injured if instructions are not followed.

Précautions de'Emploi Générales

PRÉCAUTIONS D'EMPLOI GÉNÉRALES

Les précautions d'emploi ci-dessous s'adressent à toutes les personnes susceptibles d'utiliser ou de réparer ce jeu. La présente notice renferme également d'autres mises en garde et avertissements spécifiques.

MISES EN GARDE

Mettez le jeu à la terre. Les joueurs risquent de recevoir une décharge électrique si le jeu n'est pas correctement mis à la terre! Pour éviter les décharges électriques, assurez-vous que le jeu est correctement mis à la terre avant de le brancher. Branchez-le uniquement dans une prise tripolaire avec mise à la terre. Si vous n'avez pas de prise tripolaire, il est recommandé de faire appel à un électricien breveté pour en installer une. Si la console de commande n'est pas correctement mise à la terre, les joueurs risquent de recevoir une décharge électrique! Si une réparation quelconque a été faite sur la console de commande, assurez-vous que le fil de mise à la terre est solidement attaché à l'intérieur de la console. Ceci fait, verrouillez le jeu.

Branchement sur secteur. Avant de brancher le jeu, assurez-vous que son bloc d'alimentation est compatible avec la tension secteur locale. Les conditions d'alimentation du jeu apparaissent au premier chapitre de la présente notice.

Débranchez le jeu du secteur avant toute réparation. Pour éviter les décharges électriques, débranchez le jeu du secteur avant de le démonter ou de le réparer.

Utilisez uniquement des pièces TWi. Pour éviter les risques d'accidents, utilisez toujours des pièces TWi pour réparer le jeu. L'emploi de pièces d'autres marques ou la modification des circuits du jeu sont potentiellement dangereux pour le réparateur et pour les joueurs.

Utilisez les fusibles appropriés. Pour éviter les décharges électriques, remplacez les fusibles par ceux indiqués dans la nomenclature du jeu. Les fusibles de rechange doivent être du même type, de la même tension et de la même intensité que ceux d'origine.

ATTENTION

Attachez correctement tous les connecteurs. Assurez-vous que tous les connecteurs sont bien enfichés dans les cartes circuits. Ces connecteurs sont dotés d'un détrompeur qui évite les erreurs de branchement. S'ils s'enfichent difficilement, ne forcez pas. Si vous branchez un connecteur à l'envers, vous risquez d'endommager le jeu et d'en annuler la garantie.

Vérifiez la fréquence de ligne du courant secteur. Les jeux fabriqués pour fonctionner à une fréquence de ligne de 60 Hz (fréquence utilisée en Amérique du Nord) ne doivent pas être utilisés dans les pays dont le courant a une fréquence de 50 Hz (Europe). Si vous branchez un appareil conçu pour une fréquence de 60 Hz sur un courant d'une fréquence de 50 Hz, le transformateur ballast de l'éclairage fluorescent surchauffera, ce qui présente des risques d'incendie. Vérifiez la fréquence de ligne requise par votre machine; elle est indiquée sur sa plaque signalétique.

REMARQUES, AVERTISSEMENTS ET MISES EN GARDE

Dans les publications d'TWi, les conventions, en ce qui concerne les remarques, avertissements et mises en garde, sont les suivantes:

REMARQUE — Sert à attirer l'attention sur un point particulier.

AVERTISSEMENT — Le non-respect des directives présente des risques d'endommagement et/ou de destruction pour le matériel et/ou les pièces. En cas d'endommagement ou de destruction du matériel ou des pièces, résultant du non-respect des directives, la garantie offerte sur les cartes circuits TWi et les pièces connexes TWi sera annulée.

MISE EN GARDE — Le non-respect des directives présente des risques de blessures ou d'accidents mortels pour les joueurs et/ou les réparateurs.

CONTENTS

1 Set-Up

How to Use This Manual	1-1
Operating the Game	1-2
Inspecting the Game	1-2
Control and Switch Locations	1-2
Power On/Off Switch.	1-2
Volume Control	1-2
Self-Test Switch	1-2
Coin Counter.	1-2
Video Display Controls	1-3
Setting the Coin and Game Options	1-3
Game Overview.	1-3

2 Self-Test

Introduction.	2-1
Entering and Exiting the Self-Test	2-2
Using the Gun	2-2
Select Test Menu	2-2
Adjust Volume.	2-2
Statistics.	2-3
Statistics Screen	2-3
Histogram Screens	2-3
Game Options	2-5
Coin Options	2-5
Controls Test	2-5
Gun Calibration	2-5
Disk Test	2-6
Memory Tests	2-6
Monitor Tests	2-6
Color Test	2-7
Purity Test	2-7
Convergence Test	2-7

3 Troubleshooting and Maintenance

Introduction.	3-1
Maintenance Procedures.	3-2
Introduction	3-2
Cleaning Procedure for Coin Mechanisms	3-2
Troubleshooting Procedures	3-2
Repair Procedures	3-2
Introduction	3-2
Speaker.	3-2
Attraction Panel Light Bulb	3-3
Guns.	3-3
System Logic Assemblies	3-3
Video Display	3-6

4 Parts Illustrations

For figure and page numbers, see the list of illustrations that follows.

5 Schematics

See the list of illustrations that follows.

Warranty

Inside back cover



ILLUSTRATIONS

Figure 2-1	Select Test Menu Screen.....	2-2
Figure 2-2	Adjust Volume Screen.....	2-2
Figure 2-3	Statistics Screen.....	2-3
Figure 2-4	Histograms Screen.....	2-3
Figure 2-5	Game Options Screen.....	2-5
Figure 2-6	Coin Options Screen.....	2-5
Figure 2-7	Controls Test Screen.....	2-5
Figure 2-8	Gun Test Screen.....	2-5
Figure 2-9	Disk Test Screen.....	2-6
Figure 2-10	Memory Tests Screen.....	2-6
Figure 2-11	Monitor Tests Screen.....	2-6
Figure 2-12	Color Test Screen.....	2-7
Figure 2-13	Convergence Test Screen.....	2-7
Figure 2-14	Purity Test Screen.....	2-7
Figure 4-1	Cabinet Overview, Front and Back Views.....	4-2
Figure 4-2	Gun Assembly.....	4-4
Figure 4-3	Over/Under Coin Door Assembly.....	4-5
Figure 4-4	Electronics Tray Assembly.....	4-7
Figure 4-5	Area 51 CoJag PCB Assembly.....	4-8
Figure 4-6	Area 51 EC20X32 PCB Assembly.....	4-14
Figure 4-7	Area 51 Gun PCB Assembly.....	4-16

Figure 5-1	Area 51 Game Wiring Diagram.....	5-2
Figure 5-2	CoJag Board Schematic Diagram.....	5-4
Figure 5-3	Gun Board Schematic Diagram.....	5-8
Figure 5-4	Coin Door Wiring Diagram.....	5-9

TABLES

Table 1-1	Game Specifications.....	1-2
Table 2-1	Summary of All Self-Test Screens.....	2-2
Table 2-2	Game Option Settings.....	2-4
Table 2-2	Coin Option Settings.....	2-4
Table 3-1	General Troubleshooting.....	3-4
Table 3-2	LED Indicators Troubleshooting.....	3-5
Table 3-3	Computer System Troubleshooting.....	3-6

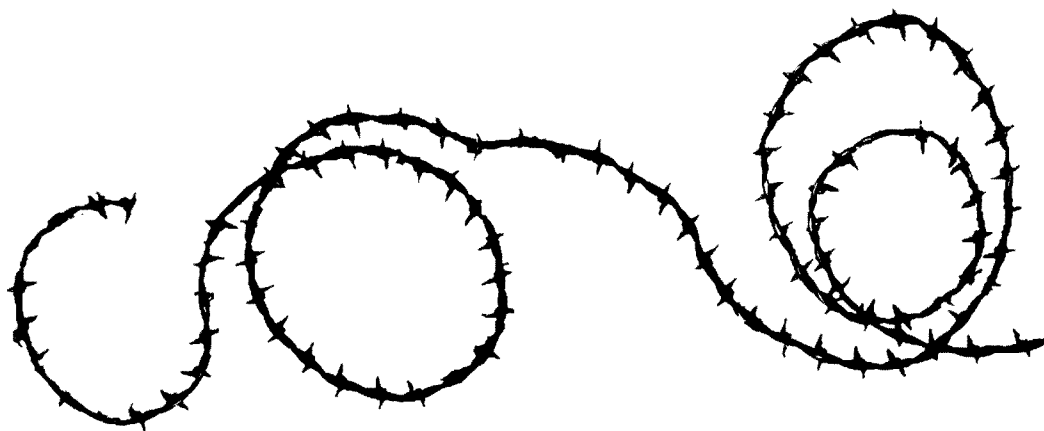

Set-Up

How to Use This Manual

THIS MANUAL IS written for operators and service personnel. It provides information for setting up, playing, testing, and maintaining your Area 51™ game.

Area 51 is a shooting game for 1- or 2-players that has a unique look and cinematic style of play due to a combination of 3D computer generated graphics, digitized live action video, and stop-motion animation.

Chapter 1 of this manual contains set-up and game play information. ♦ Chapter 2 contains a description of the self-test procedures and option settings. The self-test is important in the Area 51 game. You can troubleshoot the printed-circuit boards (PCBs), main circuits, and controls using the screens in the self-test.

You should regularly test the boards and controls with the self-test to keep your game in peak condition and at top earnings. ♦ Chapter 3 contains several troubleshooting tables, plus maintenance and repair procedures for the game components. If you have problems with your game, use this chapter to troubleshoot and repair it. Be sure to perform the preventive maintenance tasks to keep your game in good condition. ♦ Chapter 4 contains the illustrations and PCB parts lists. ♦ Chapter 5 contains the schematics for all the PCBs and all the wiring diagrams.



Operating the Game

To operate your game for maximum income, you should regularly run the self-test and check the controls with the Control Test and Sound Test in the self-test. By using the self-test regularly, you can find and fix problems immediately. This lets you keep your game in top condition.

Inspecting the Game

WARNING

To avoid electrical shock, do not plug in the cabinet until it has been properly inspected and set up for the line voltage in your area.

This cabinet should be connected to a grounded three-wire outlet only. If you have only two-wire outlets, we recommend that you hire a licensed electrician to install grounded outlets. Players can receive an electrical shock if the cabinet is not properly grounded.

Make note of the power consumption when you set up this game, so that you do not overload your electrical circuit. See Table 1-1 for the power consumption and the other important specifications of this game.

Inspect your Area 51 game carefully to ensure that the game is complete and was delivered to you in good condition. Inspect the cabinet as follows:

1. Examine the exterior for dents, chips, or broken parts.
2. Unlock and open the rear access door. Unlock and open the coin doors. Inspect the interior of the cabinet as follows:
 - a. Check that all plug-in connectors on the cabinet harnesses are firmly plugged in. Do not force connectors together. The connectors are keyed so they fit only in the proper orientation. A reversed connector can damage a printed-circuit board (PCB). This will void your warranty.
 - b. Ensure that all plug-in integrated circuits on each PCB are firmly plugged into their sockets.
 - c. Inspect the power cord for any cuts or dents in the insulation.
 - d. Inspect the power supply. Check that the harness is plugged in correctly. Check that the green ground wires are connected.

Characteristic	Specification
Input Current	3 Amps at 120 V
Line Voltage	102 to 132 VAC
Temperature	5° to 38° C (37° to 100° F)
Humidity	Not to exceed 95% relative
Width	29.25 inches (75 cm)
Depth	34 inches (87 cm)
Height	72 inches (183 cm)
Weight	325 lbs. (148 kg)

Table 1-1 Game Specifications

- e. Inspect other sub-assemblies, such as the video displays, controls, printed-circuit boards, and speaker. Make sure that they are mounted securely and that the ground wires are connected.

Control and Switch Locations

All of the controls are located on the back of the cabinet or behind the coin doors. The following describes the locations in more detail:

Power On/Off Switch

The power on/off switch is located near the bottom of the rear door.

Volume Control

There is no volume adjustment knob on any PCB in this game. Instead, volume is adjusted in the self-test software. The attract-mode and game-play volumes can be adjusted separately. Refer to Chapter 2 of this manual for more information.



Self-Test Switch

To perform the self test, open the upper coin door and activate the self-test switch mounted on a bracket located on the inside panel of the game cabinet.

Coin Counter

The coin counter is located below the coin box, inside the lower coin door.

Video Display Controls

This game provides access to six of the most important video display controls — vertical and horizontal position, vertical hold, vertical size, black level, and contrast. To gain access to the video display controls, open the upper coin door. The control knobs are mounted on the inside panel of the game cabinet.

Setting the Coin and Game Options

The Area 51 coin and game options are set in the self-test. Refer to Chapter 2 for the recommended settings and the procedure for setting the options.

Game Overview

This section describes the features and play of the Area 51 game.

Introduction

Area 51 is a shooting game for one or two players that has a unique look and cinematic style of play due to a combination of computer-generated graphics, digitized live-action video, and stop-motion animation.

Area 51's Features

- Reliable controls, provided by Time Warner's own AccuAim targeting system, a custom-designed circuit that allows for very accurate performance.
- Scoring enhancers and hidden features that will make Area 51 easy to learn but hard to master, ensuring long-lasting game depth.

Background

The game is set at the fabled Area 51 military base in Nevada. One of the most top-secret military bases in the world, Area 51 is so top secret that as far as the government is concerned, it *does not exist*. There is a great deal of speculation about what actually takes place at Area 51, and more than a hint of conspiracy. While it is believed that many of the most advanced aircraft, including the SR-71 Blackbird and the Stealth Fighter were tested there, there are also rumors and testimonials by ex-employees that the government has captured alien spacecraft (UFOs) that are studied in a facility at the base. Other rumors hint at genetic studies

of dead alien bodies, development of deadly biological warfare weapons, and nuclear weapons testing.

Players are members of the STAAR Team (Special Tactical Advanced Alien Response), a secret paramilitary force who tackle dangerous jobs beyond the ability of the conventional military. As the game begins, the STAAR Team lands on the front tarmac of the air base and then they work their way through six security levels. Along the way, players must avoid being hit by armed enemies, helicopters, missiles, explosions, and deadly aliens. There are plenty of hidden weapons and surprises to help players out along the way.

At first, players don't know why they are being called in to destroy Area 51. As the game goes on, they realize that events at Area 51 have gotten horribly out of control. The personnel at the base are decaying into zombie-like creatures who are just the first stage in a horrible transformation, the end-stage of which is an amazing alien being who is fast, heavily armored, and equipped with deadly weapons.

Game Play

To win the game, players must play through all six levels of the game and beat the final end-game stage. To do this, they must pick up secret weapons and other power-ups hidden at various areas around the base. Players must blast away all the obstacles in their path while avoiding hitting their fellow STAAR Team members.

To give the game a movie-like feel, the "camera" moves players around the base, with a pace that varies according to the wave. For some waves, the camera explores the environment slowly and methodically, while other waves have a faster tempo. In one wave, players are taken on a wild Jeep ride, careening around the complex and crashing into objects as they shoot enemies and avoid being shot themselves. Players also take rides on elevators, forklifts, and helicopters at strategic points in the game.

Players are encouraged to explore their environment by shooting everything in order to find the hidden features and reveal the scoring bonuses.

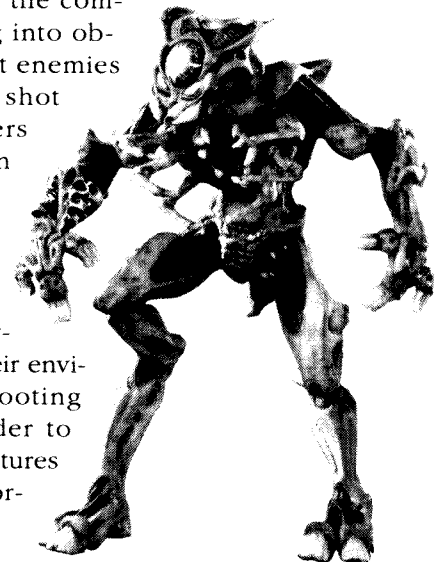

N O T E S

Self-Test

Introduction

USE THE AREA 51™ self-test to check the condition of the game circuitry and controls. You will see the self-test information on the video display and hear the sound test information through the speakers. You do not need any additional equipment to perform the self-test. Perform the self-test when you first set up the game, each time you collect the money, or when you suspect game problems. This chapter shows the screens in the self-test and explains each of the tests. The screens and explanations are arranged in the order they appear in the self-test. Table 2-1 lists all the self-test screens.



Entering and Exiting the Self-Test

The game's self-test switch is located behind the upper coin door. Turning it on causes the screen to enter the self-test mode. Doing so displays the Select Test menu; see Figure 2-1. Exit the self-test by turning off the self-test switch at any time.

It is likely that version numbers shown in the self-test screens in this manual will be different from those shown on your game. The functioning of the menus, however, will be the same.

Using the Gun

Either gun can be used in the self test menus to make selections or adjustments. A menu item can be selected by aiming the gun at it and then clicking the gun trigger. A menu item can be run by aiming the gun at it and clicking the trigger twice. The top, bottom, left, and right of the screens that are marked with arrows can be activated with the gun to move up and down the menu, to change selections, and to make adjustments (such as the game volume).

Select Test Menu

Choose which test or screen you want to run from this menu, shown in Figure & Table 2-1. Run the item by shooting it twice with a gun or by pressing the left start button to select it and then the right start button to run it.



Figure 2-1 Select Test Menu Screen

Select Test Menu

<i>Adjust Volume</i>
<i>Statistics</i>
Statistics
Histograms
<i>Game Options</i>
<i>Coin Options</i>
<i>Controls Test</i>
<i>Gun Test</i>
<i>Disk Test</i>
<i>Memory Tests</i>
Color RAM
Working RAM
DRAM Bank 1
DRAM Bank 2
All RAM
ROM Test
<i>Monitor Tests</i>
Color Test
Purity Test
Convergence Test

Table 2-1 Summary of All Self-Test Screens

Adjust Volume

Adjust the volume of the game using this screen, shown in Figure 2-2.

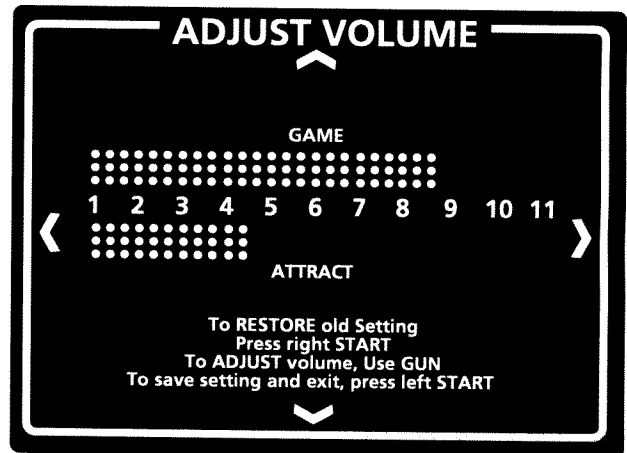

Figure 2-2 Adjust Volume Screen

The software plays continuous music to allow you to adjust both the game and attract-mode volume levels. The word *GAME* or *ATTRACT* flashes to show which of the two volumes levels you are adjusting. Fire the gun at the top or bottom of the screen to select between the two and to the left or right of the screen to adjust volumes. The attract-mode volume level has four steps: mute, 1/3, 2/3 or full volume level (these

are fractions of the game volume level). The manufacturer's suggested volume levels for a moderately noisy environment are GAME at 9 and ATTRACT at 2/3.

Statistics

Use the information shown in the statistics and histogram (bar graph) screens to keep track of your game use and maximize your profits.

The game statistics are collected from the last time the statistics were cleared. Follow the instructions at the bottom of the screen to clear the statistics or to advance to the histogram screen.

Statistics Screen

The Statistics screen (see Figure 2-3) lists the following information:

- Left Coins shows the number of coins counted in the left coin mechanism.
- Right Coins shows the number of coins counted in the right coin mechanism.
- Aux Coins shows the number of coins manually added by the operator (not inserted into any mechanism).
- Idle Minutes shows the number of minutes that the game was idle and not being played.
- 1-Player Minutes/2-Player Minutes shows the number of minutes that the game was played by one or two players.
- New Game Minutes shows the number of minutes played after starting a new game.
- Continued Game Minutes shows the number of minutes played after continuing a game.

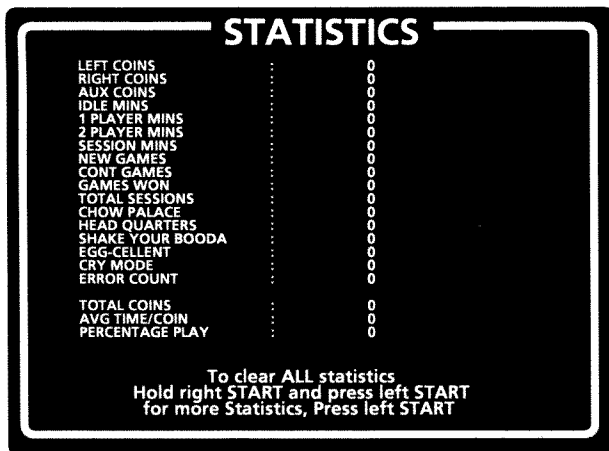

Figure 2-3 Statistics Screen

- Games Won shows the number of games that have been played to the finish.
- Total Sessions shows the number of different sessions (new and continued games). A "session" is measured from the time the first player starts to play (from attract mode) to the time the last remaining player declines to continue. Any number of players may join or leave during a session. This statistic is intended to be a gauge of the "band wagon" effect, where players are attracted to join a game in progress.
- Chow Palace, Head Quarters, Shake your Booda, and Egg-cellent show the number of times a secret room has been entered.
- Cry mode shows the number of times that the Cry mode effect has been active.
- Error count shows the number of errors counted in erasable memory. If the game consistently has an error count for several weeks, the PCB EPROM may need replacement.
- Total Coins shows the number of coins counted in both left and right coin mechanisms.
- Average Time per Coin shows an average of the number of minutes played for every coin counted.
- Percentage Play shows the ratio of game playing time to total time the game has been turned on.

Histogram Screens

The Histograms screen is a menu that lets you display one of three screens (see Figure 2-4). These show horizontal bar graphs for new game times, continued game times, and session length.



Figure 2-4 Histograms Screen

Game Option	Available Settings	Explanation
End Game Looping	On ✓ Off	When set to <i>On</i> , the game will “loop” from the final screen back to the beginning screen. When set to <i>Off</i> , the game ends at the final screen.
Game Difficulty	Easy Medium ✓ Difficult	Provides a choice of 3 levels of game difficulty. Changing this setting will reset the High-Scores memory.
Gore	On ✓ Off	Turning gore off removes any animation with red blood.
Secret Room	On Off ✓	Turns on or off a room containing “Buddha” statues. Using the off setting deletes the Buddha Room and replaces it with another secret room.
Reset High Scores	No ✓ Yes	Choosing <i>Yes</i> will reset all high scores (upon leaving the Game Options Screen).
Reset Factory Options	No ✓ Yes	Choosing <i>Yes</i> will reset the game to the original factory settings (upon leaving the Game Options Screen).
Number of Lives	3, 4 ✓, 5, 6, or 7	Sets number of lives per credit.
Language	English ✓ Japanese German Spanish French	Chooses the language for the screen text.

✓ *Manufacturer's recommended settings*

Table 2-2 Game Option Settings

Coin Option	Available Settings	Explanation
Free Play	No ✓ Yes	Lets you choose free play to demonstrate the game.
Discount to Continue	No Yes ✓	When set to <i>Yes</i> , this option reduces by 50% the player's cost to continue a game (always rounded up to the next full coin).
Game Cost	1 coin 1 credit 2 coins 1 credit 3 coins 1 credit ✓ ... 8 coins 1 credit	The number of coins required for one credit.
Bonus for Quantity Buy-in	None ✓ 2 coins give 1 3 coins give 1 3 coins give 2 ... 9 coins give 2 9 coins give 3	Lets you choose from various kinds of bonuses or no bonus.
Right Mech Value	1 coin counts as 1 coin ✓ 1 coin counts as 2 coins ... 1 coin counts as 7 coins 1 coin counts as 8 coins	The number of coins each coin counts as in the right coin mechanism.
Left Mech Value	1 coin counts as 1 coin ✓ 1 coin counts as 2 coins ... 1 coin counts as 7 coins 1 coin counts as 8 coins	The number of coins each coin counts as in the left coin mechanism.

✓ *Manufacturer's recommended settings*

Table 2-3 Coin Option Settings

Game Options

Check and select the game options on this screen, shown in Figure 2-5. The screen shows the factory default settings in green.

Use the gun to change the game options as desired. The game option settings, with defaults, are shown and explained in Table 2-2.

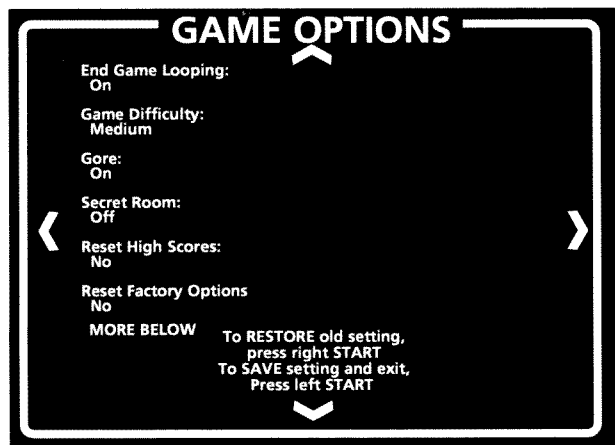

Figure 2-5 Game Options Screen

Coin Options

Check and select the coin options on this screen, shown in Figure 2-6. The screen shows the factory default settings in green.

Use the gun to change the coin options as desired. The coin option settings, with defaults, are shown and explained in Table 2-3.

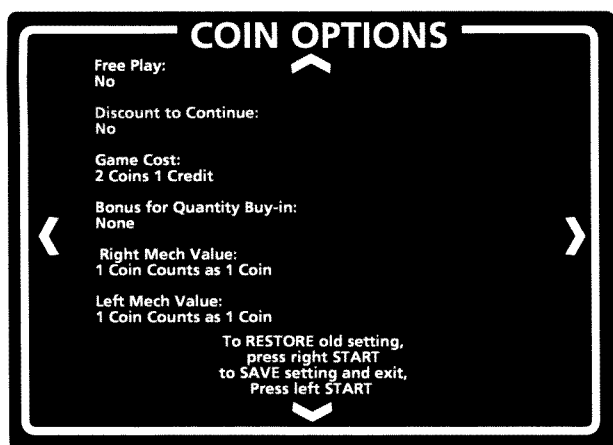

Figure 2-6 Coin Options Screen

Controls Test

The controls test screen is shown in Figure 2-7. This test checks the pushbutton switches, the gun triggers, and the coin mechanisms.

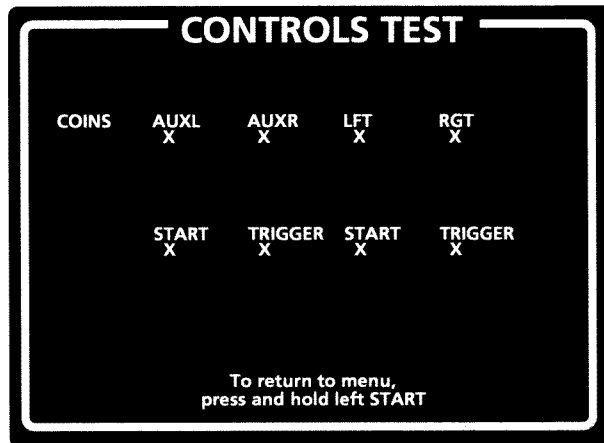

Figure 2-7 Controls Test Screen

The X markings change to O markings each time a control is activated. If the changes do not occur, check the controls and their wiring.

Gun Test

The gun test screen is shown in Figure 2-8. This test checks and calibrates the guns.

NOTE

Well calibrated guns are important for player's enjoyment. Calibrate the guns often to keep the game at peak earnings.

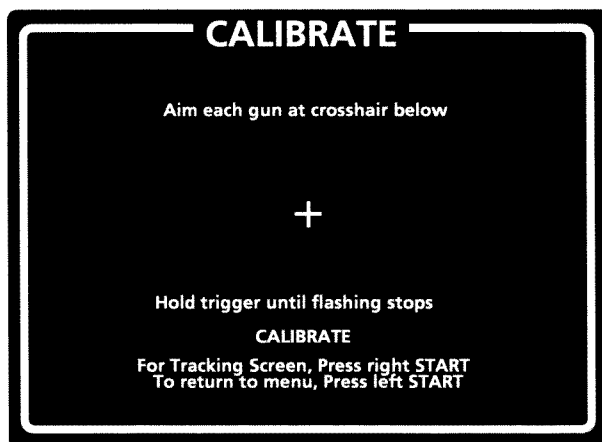

Figure 2-8 Gun Test Screen

Each gun is calibrated separately. Hold one gun at a normal playing distance from the screen. Use the sights to aim the gun at the cross hairs on the screen. Press and hold the trigger until the screen stops flashing and the word "DONE" appears (in the same color as the gun that you are calibrating). The gun is now calibrated. Repeat the process with the other gun.

Use the tracking screen to verify that the gun tracks evenly across the entire screen (with the exception of the edges, which are used as a buffer zone).

Exit to the main menu to save the calibration settings.

Disk Test

Use the Disk Test screen, shown in Figure 2-9, to test the hard disk.

If the "Hard Drive Connected:" display shows "No", check that all of the cables going to the drive are secure.

The test will continue running until the left start button is pressed. Normally, the "Status" of the drive will display as "Good". If the "Status" displays "Bad", check the cables going to the drive, then run the test again.



Figure 2-9 Disk Test Screen

Memory Tests

Use this selection screen, shown in Figure 2-10, to run a memory test. These tests check the RAM and ROM chips.

When the game power is turned on, the computer automatically runs through the random-access memory (RAM) tests. To bypass the startup RAM test, tap the right start button repeatedly.

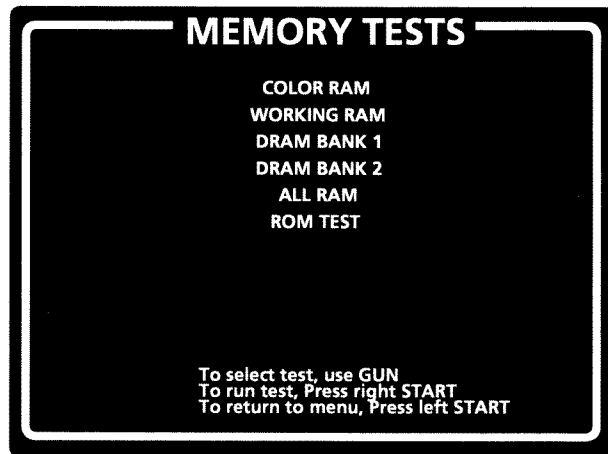

Figure 2-10 Memory Tests Screen

Monitor Tests

The monitor test selection screen (shown in Figure 2-11) lets you select from three screens — color, purity, and convergence. Advance to each screen to completely test the monitor.



Figure 2-11 Monitor Tests Screen

Color Test

The color test (see Figure 2-12) indicates the dynamic range of the video display color circuitry. The screen should show four bands (red, green, blue and white), ranging from dark to bright, from left to right. The red, green, and blue bands are produced by only one color gun being turned on in each band.

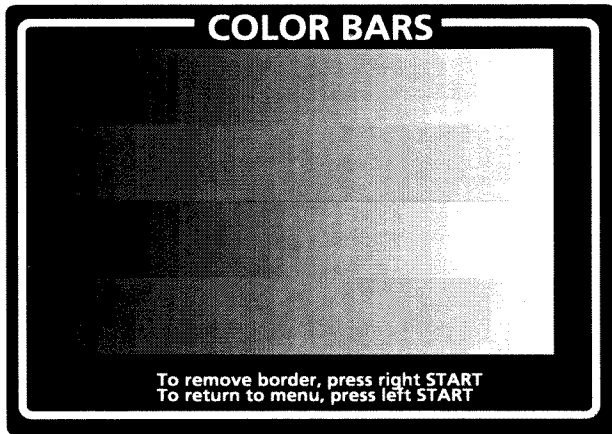

Figure 2-12 Color Test Screen

Convergence Test

The convergence test has three screens — white, violet, and green backgrounds with grid lines. This sequence is then repeated but without any text on the screen. The green screen is shown in Figure 2-13. To see the remaining screens or return to the select test menu, follow the instructions shown at the bottom of the screen.

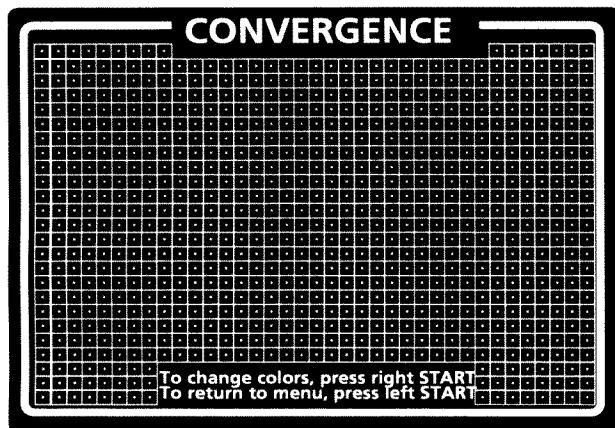

Figure 2-13 Convergence Test Screen

Check the following on the screens:

- The grid lines should be straight within 3.0 mm and the lines should not pincushion or barrel.
- The convergence of the lines on the violet and green screens should be within 2.0 mm.

Purity Test

The next seven screens are color purity tests (see Figure 2-14). The entire screen will be red, green, blue, white, grey, “ones”, and black. The “ones” screen shows the lowest possible intensity of color (almost black). Press the right start button to change colors. The seven screens are also repeated without text, so

that the entire screen can be checked. Each screen should show no unevenness of color and no lines in the display.

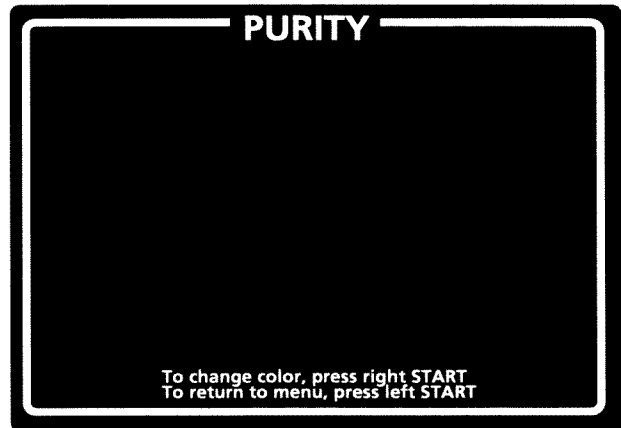

Figure 2-14 Purity Test Screen

If these screens do not meet these criteria, adjust the video display as described in the video display manual.

N O T E S

Troubleshooting & Maintenance

Introduction

THIS CHAPTER contains maintenance, troubleshooting, and repair procedures for your Area 51™ game. The maintenance section gives information on cleaning the parts. The troubleshooting section contains several tables to help determine the source of a problem and the steps necessary to repair it. The repair section contains the steps necessary to remove and install the serviceable parts. Together, these three sections provide a complete guide to servicing your Area 51™ game.

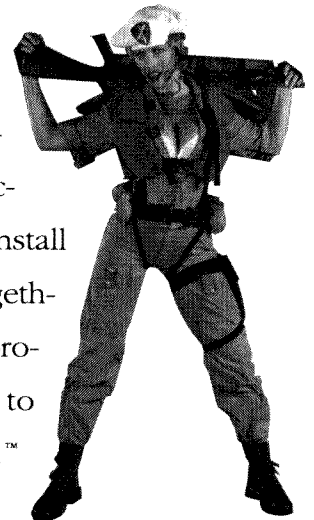

Maintenance Procedures

Introduction

This section describes the maintenance procedures for all of the major assemblies and components of the game. The maintenance procedures should be performed every 3–4 months on a regular basis.

WARNING

Before performing any maintenance or repairs, please observe all of the following safety precautions:

1. Turn the game's power off.
2. Unplug the power cord from the electrical socket.
3. Secure loose clothing such as ties and long sleeves that could get caught within the game.
4. Remove all metal jewelry such as watches and necklaces that could conduct electricity from the game's power sources.

Cleaning Procedure for Coin Mechanisms

Regular use of the coin mechanisms may result in a build-up of residue and dirt. If this is the case, clean the coin mechanism by following the steps below (refer to Figure 4-3 for detailed part information on the coin door).

1. Open the upper coin door.
2. Open the gate on the door that covers the magnet. Use the blade of a screwdriver to scrape away any metal filings that have collected on the magnet.
3. Clean the loose dust and dirt from the coin mechanism with a lint-free rag or a soft brush.
4. Clean the dirt and residue from the coin path with a toothbrush. Hot, soapy water may be used to help dissolve dirt and residue.
5. Blow out all the loose dirt and dry the coin mechanism with compressed air.
6. Close the gate on the door that covers the magnet and close the upper coin door.

CAUTION

Never lubricate the coin mechanism with oil or grease.

Troubleshooting Procedures

This section is designed to help determine the source of a malfunction and provide detailed information on repairing the problem.

Table 3-1 General Troubleshooting, is divided into two columns. The left-hand column is broken down into the general nature of problems. The right-hand column lists suggested solutions to solve the problem.

Table 3-2 Area 51 PCB LED Indicators Troubleshooting, helps determine the cause of problems with the computer circuit boards or the hard disk drive by checking the status of the indicator LED's. The left-hand column lists the various states. The middle column explains the meaning of the state. The right-hand column suggests actions to correct a problem.

Table 3-3 Computer System Troubleshooting, helps determine the cause of game operation problems. The left-hand column list symptoms. The middle column explains the probable cause of the symptom. The right-hand column suggests actions to correct a problem.

Repair Procedures

Introduction

This section describes the repair procedures for all of the major assemblies and components of the game. Before performing any repairs, use the tables in the *Troubleshooting Procedures* section and the screens in the *Self Test* software to help determine the source of the problem. The *Maintenance Procedures* section may also provide a good starting point for fixing many game problems before beginning what might be unnecessary repairs.

Speaker

Each game has a single speaker located in the middle of the control panel. The speaker provides the music and sounds for the game and self-tests. Failure of the speaker may result in distorted or no sound. If this is the case,

replace the speaker using the removal and installation steps below.

1. Remove the six screws securing the speaker grille; remove the speaker grille and set aside.
2. Remove the four speaker mounting screws.
3. Disconnect the harness from the speaker.
4. Replace and reinstall the speaker in reverse order.

Attraction Panel Light Bulb

Use the light access door located on the top rear of the cabinet to replace the attraction panel light bulb.

1. Remove the two screws securing the light access door.
2. Unlock the access door and remove it.
3. Remove the cardboard bulb retaining clips one at a time by pressing on the circular tab and pulling the clip out.
4. Remove the bulb by rotating it and pushing it upwards.



Guns

To detach the gun and its cable for repair or replacement, use the following steps.

CAUTION

Unplugging the guns from the wiring harness while the power is on can damage the PCB.

1. Open the upper coin door.
2. Disconnect the gun wire connector from the wiring harness.
3. Unfasten the the three flat washers and nuts that secure the gun cable mount.

Use the self test to calibrate the guns after installation.

System Logic Assemblies

This section describes the repair and maintenance procedures for the assemblies and components that are related to the system's logic and electronics, including the printed-circuit boards (PCBs) and the power supply. These components are mounted on the electronics tray and are accessed by opening the rear door.



Area 51 Game PCB Set

The Area 51 game PCB set (board stack) is responsible for the display graphics and game play. Failure of the game PCB set may result in erratic or no game play. If this is the case, repair or replace the game

PCB set by following the removal and installation steps below.

1. Remove the four retaining screws securing the rear door.
2. Unlock the rear door and remove it.
3. Disconnect the harness connectors from the game PCB set. (There are 5 connectors in all.)

CAUTION

Before handling static-sensitive components, properly ground yourself to discharge buildup of static charges.

4. Unfasten the three screws and spacers that secure the game PCB set to the electronics tray. Remove the game PCB set (refer to Figure 4-4.)
5. Re-install the game PCB set by following the previous steps in the reverse order.



Hard Disk Drive

The hard disk drive unit stores the sound and graphics information for the game program.

CAUTION

Handle with Care!

The hard disk drive can be damaged by a strong impact. Handle it gently to prevent damage. The hard disk drive can also be damaged by electrostatic discharge. Use the same precautions as used for the PCB.

1. Disconnect the ribbon and power cables from the disk drive.
2. Remove the four mounting screws that secure the disk drive to the mounting bracket.

Power Supply — Adjustment

CAUTION

Adjust the power supply slowly to prevent over-voltage damage to the PCB. During adjustment, do not push the adjustment knob hard with the screwdriver, because it is an easily damaged plastic part.

The 5 volt power (supply) adjustment knob is located on the top of the power supply and can be turned with a *small* flat-blade screwdriver. If the power LED indicators show that the voltage needs to be adjusted (see Table 3-2), use the following procedure.

Problem	Suggested Action
Coin Mechanism Problem	<ol style="list-style-type: none"> 1. Check the wiring connections to the coin mechanism. 2. Check the voltage to the + side of the mechanism. 3. Test the coin mechanism with the Controls Test screen in the self-test.
Gun Problem	<ol style="list-style-type: none"> 1. Check gun lens for dirt or blockage. 2. Test the gun with the Gun Test screen in the self-test. 3. Check the harnesses and connectors. 4. If you took the gun apart, have you reassembled it correctly? 5. Make sure all the parts of the gun are in good order. Repair or replace parts as needed. 6. Check to see if any bright lights in the game area are interfering with gun operation.
Sound Problem	<ol style="list-style-type: none"> 1. Check the speaker volume setting: make sure the volume isn't zero! 2. Test the sound with the Sound Test screen in the self-test. 3. Check the resistance of the speaker for 4 Ohms.
Video Display Problem	
Screen is dark	<ol style="list-style-type: none"> 1. Check to see that the game is plugged in and powered on. 2. Check the line fuse if no power is present. 3. Check the display brightness. 4. Check the edge connector to the PCB. 5. Check the harnesses and connectors to the video display PCB. 6. Check the voltage levels to the video display PCB. 7. Run through the following checklist. If you answer <i>no</i> to any question, you have a problem with the video display, not with the game circuitry. In this case, refer to your video display service manual. <ol style="list-style-type: none"> a. Do you have power to the video display? b. Are the video display's filaments lit? c. Do you have the correct voltage to the video display?
Only a colored screen appears	<ol style="list-style-type: none"> 1. Attempt to run a complete memory test in the self-test. 2. Replace the ROM if a ROM failure is reported in the self-test.
Picture wavers or is too small	<ol style="list-style-type: none"> 1. Check the voltage levels to the video display PCB. 2. Check the B+ to the video display. (Refer to the video display manual.)
Picture is wavy	<ol style="list-style-type: none"> 1. Check the connection of the monitor ground wire to the monitor. 2. Check the connections of the sync inputs.
Picture is upside down or reversed	<ol style="list-style-type: none"> 1. If you replaced the monitor recently, check the horizontal or vertical yoke wire connections to the video display. They may be switched.
Convergence, purity or color problems	<ol style="list-style-type: none"> 1. Use the self-test mode to digitally adjust the video display. 2. Use the adjustment procedures in your video display manual.
Picture is not centered	<ol style="list-style-type: none"> 1. Use the centering procedures in your video display manual.

Table 3-1 General Troubleshooting

LED Indicator	Meaning	Action
DRIVE_BUSY (YELLOW — located near the hard disk cable)		
Flashing Intermittently	Normal	
Continuously OFF	Hard Disk not reading	Check the cables connected to the disk
Continuously ON	Hard Disk Error	Check the cables connected to the disk
Program WatchDog (GREEN — located near the four ROM chips on the top board)		
Continuously ON	Normal	
Blinking	ROM problem	Check the program EPROM for bent pins
POWER (GREEN — located near the JAMMA connector)		
Continuously ON	Normal	
Continuously OFF	No power is reaching the board	Check the power supply and cables
TOO_LOW (RED — located next to the power LED)		
Continuously ON	Power supply voltage too low	Adjust the power supply, as explained in the Repair Procedures
TOO_HIGH (RED — located next to the power LED)		
Continuously ON	Power supply voltage too high	Adjust the power supply, as explained in the Repair Procedures

Table 3-2 LED Indicators Troubleshooting

- | | |
|---|--|
| <ol style="list-style-type: none"> 1. If the TOO_HIGH LED is on, skip to step 2. Otherwise, slowly raise the voltage until the TOO_HIGH LED turns on. 2. Slowly lower the voltage until the TOO_HIGH LED turns off. | <ol style="list-style-type: none"> 1. Remove the four retaining screws securing the rear door. 2. Unlock the rear door of the cabinet and remove it. 3. Disconnect the wiring harnesses from the power supply. 4. Unfasten the two screws securing the top bracket and remove it. 5. Unfasten the two screws that secure the power supply assembly to the cabinet, and remove the power supply assembly. 6. Re-install the power supply assembly by following the previous steps in the reverse order. |
|---|--|



Power Supply — Replacement

The power supply provides power to all of the game assemblies that require it.

NOTE

The power supply has no user-serviceable parts. Call your distributor for advance replacement. Return the power supply in an approved shipping container.

Failure of the power supply may result in erratic game play or no power at all. If this is the case, repair or replace the power supply assembly by following the steps below.

WARNING

The power supply can contain high voltages even after the power switch is turned off. To avoid injury, observe all of the safety precautions before working on the power supply. (Refer to the Introduction in the Maintenance Procedures section.)



ROMs

The ROMs contain the programming routines used by the game PCB set to control game play. Replace the damaged ROMs by following the removal and installation steps below.

1. Remove the game PCB set according to the procedure in the *Area 51 Game PCB Set* section.

CAUTION

Before handling static-sensitive components, properly ground yourself to discharge buildup of static charges.

Section/Symptom	Meaning	Action
Hard Disk/ "ZERO DIVISION" message at top of screen	Hard disk not connected	Check the cables that connect the hard disk to the game PCB.
EEPROM/ "SETTING EEPROM DEFAULT VALUES" message appears during every start & the high score table is empty	EEPROM bad	Replace the EEPROM.

Table 3-3 Computer System Troubleshooting

2. Remove the damaged ROMs from the game PCB set using a chip extraction tool.
3. Install the new ROMs by plugging them in the game PCB set sockets.
4. Re-install the game PCB set by following the steps in the *Area 51 Game PCB Set* section in the reverse order.
3. Discharge the high voltage from the cathode-ray tube (CRT).

NOTE

The label on the video display assembly shows a circuit for discharging the high-voltage contained in the CRT to ground when the power is off.



Video Display

To repair, replace or make adjustments to the video display, follow the removal and installation steps below.

WARNING

High Voltage

The video display contains lethal high voltages. To avoid injury, do not service this display until you observe all precautions necessary for working on high-voltage equipment.

X-Radiation

This video display is designed to minimize X-radiation. However, to avoid possible exposure to soft X-radiation, never modify the high-voltage circuitry.

Implosion Hazard

The cathode-ray tube (CRT) may implode if struck or dropped. The shattered glass from the tube may cause injury up to six feet away. Use care when handling the display and when removing it from the game cabinet. Also, wear gloves to protect your hands from the sheet-metal edges.

- a. Secure one end of a solid 18-gauge wire to a well-insulated or wooden handle screwdriver.
- b. Secure the other end of the wire to an earth ground.
- c. Briefly touch the blade end of the screwdriver to the CRT anode by sliding it under the anode cap.
- d. Wait 2 minutes and repeat the previous step.
4. Disconnect all of the wire harnesses from the video display.
5. Unfasten the three square-drive screws (on the top of the cabinet) that secure the front shield and remove it.
6. Unfasten the four flat washers and nuts that secure the video display chassis to the cabinet monitor mounting brackets.
7. Remove the video display assembly from the cabinet.

CAUTION

Do not attempt to remove the video display without its chassis.

1. Remove the four retaining screws securing the rear door.
2. Unlock the rear door and remove it.

8. Install the new video display by following the previous steps (excluding steps 3a.-3d.) in the reverse order.
9. If necessary, adjust the new video display's brightness, size, centering, purity and convergence according to the video display service manual.

Parts Illustrations

Part Ordering Information

THIS CHAPTER provides information you need to order parts for your game. The printed-circuit board (PCB) parts lists are arranged in alphabetical order by component. Within each section the parts are arranged numerically by part number. When you order parts, give the part number, part name, the number of this manual, and the serial number

of your game. With this information, we can fill your order rapidly and correctly. We hope this will create less downtime and more profit from your games.

Time Warner Interactive Customer Service phone numbers are listed on the inside front cover of this manual.

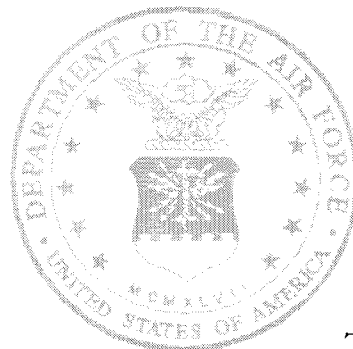

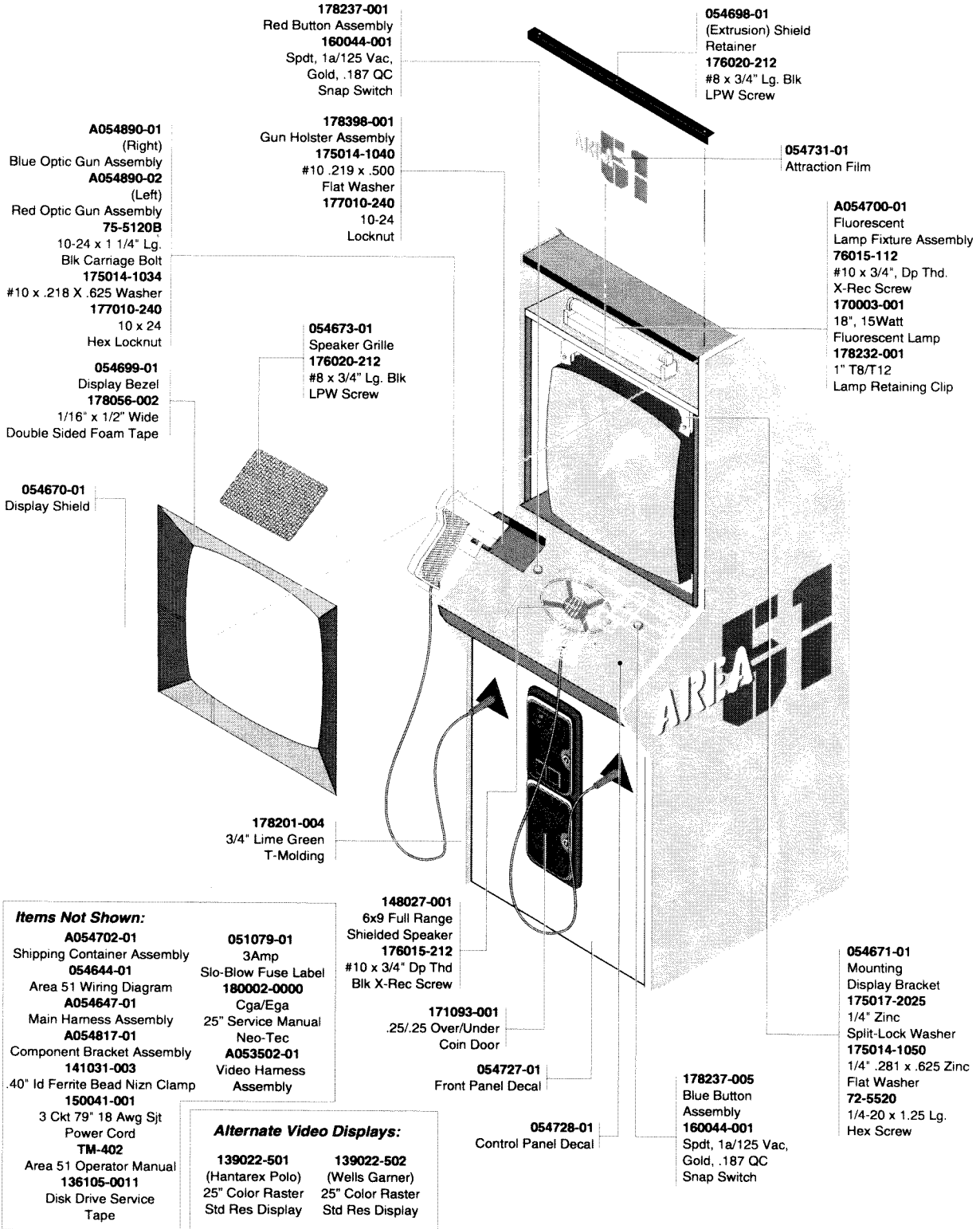

Figure 4-1 Cabinet Overview, Front and Back Views

A054731-01

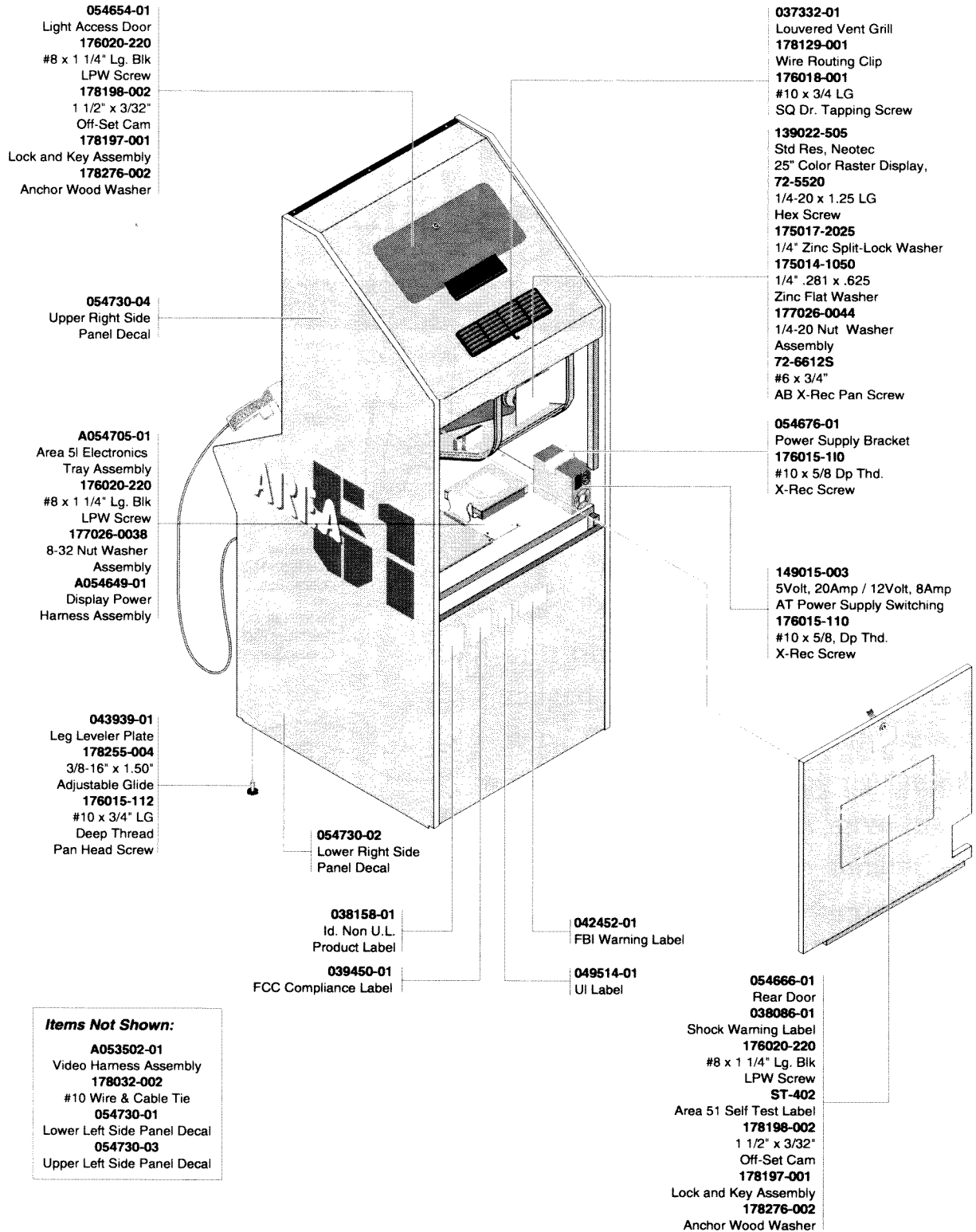

Figure 4-1 Cabinet Overview, Front and Back Views, Continued

A054731-01

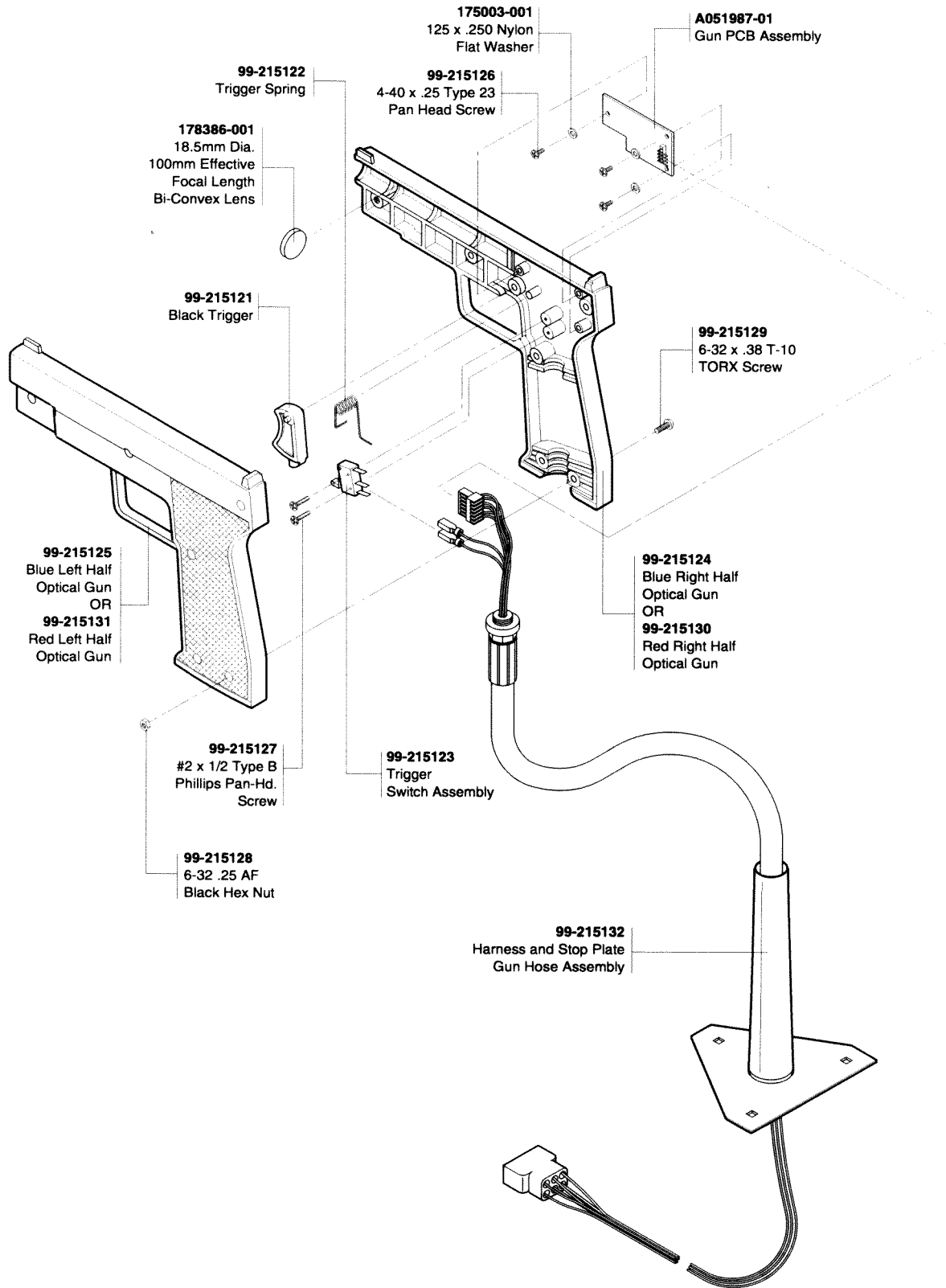

Figure 4-2 Gun Assembly

A054890-01 (blue), A054890-02 (red)

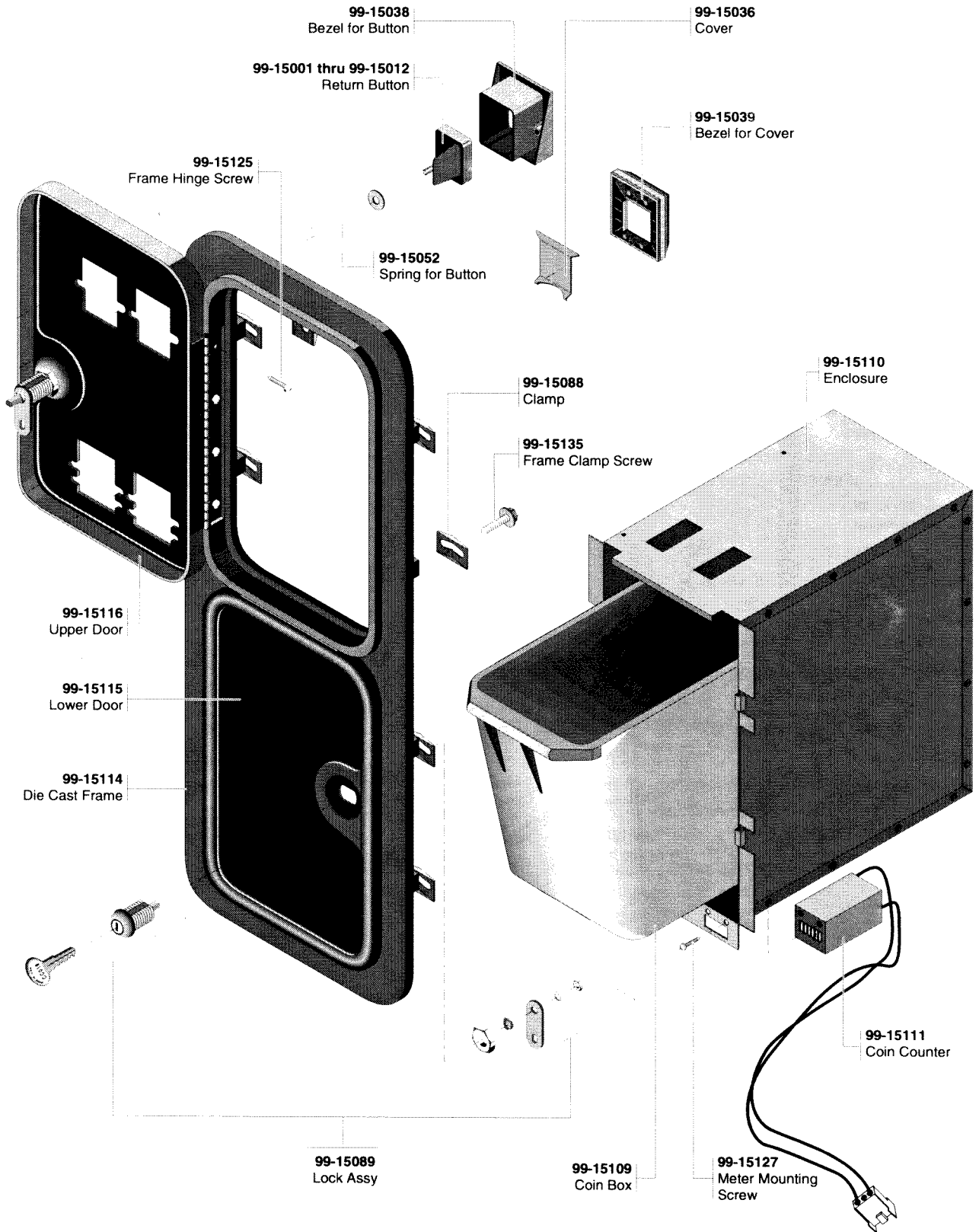

Figure 4-3 Over/Under Coin Door Assembly

171093-001

(This figure is continued on next page)

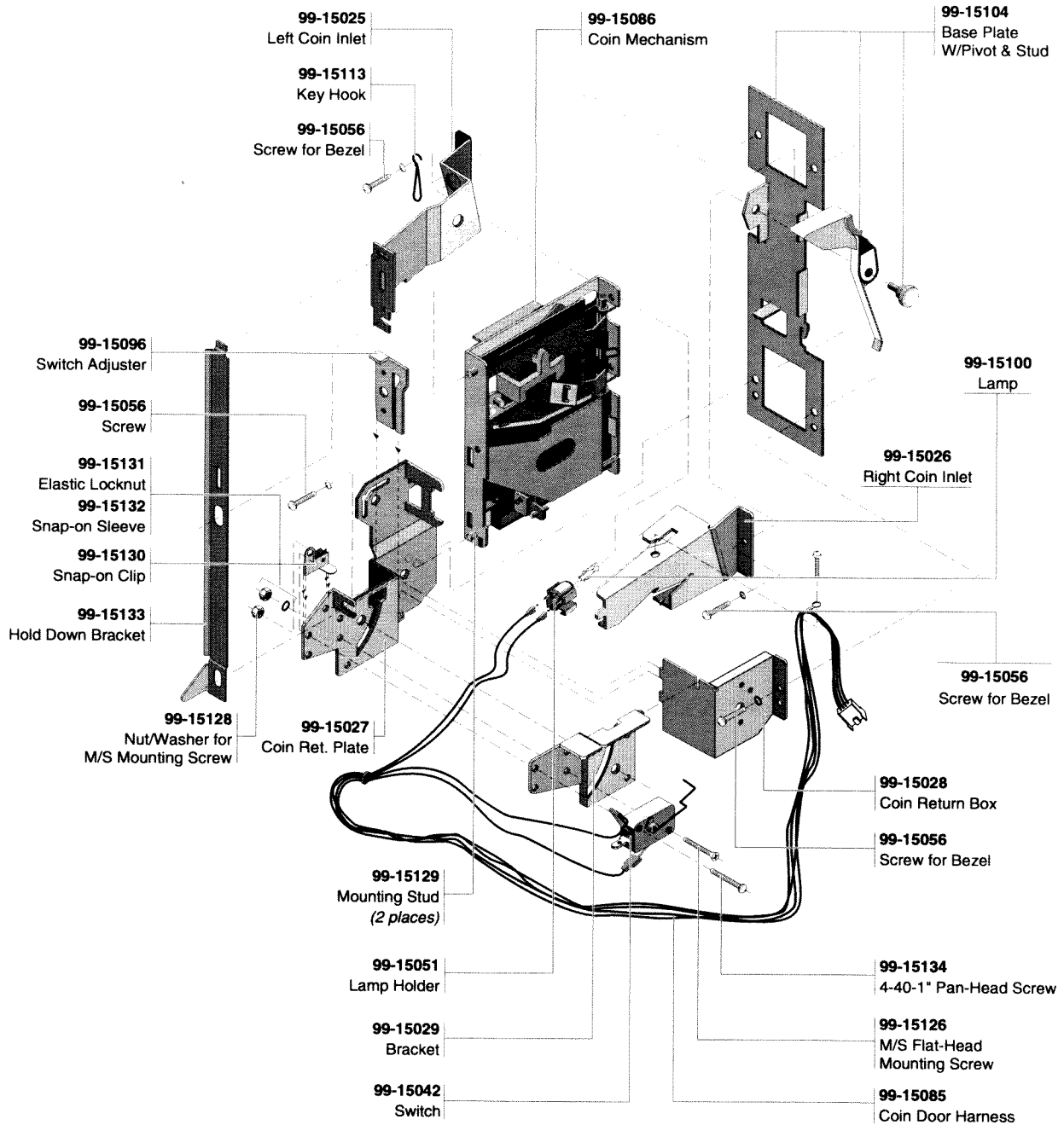

Figure 4-3 Over/Under Coin Door Assembly

171093-001

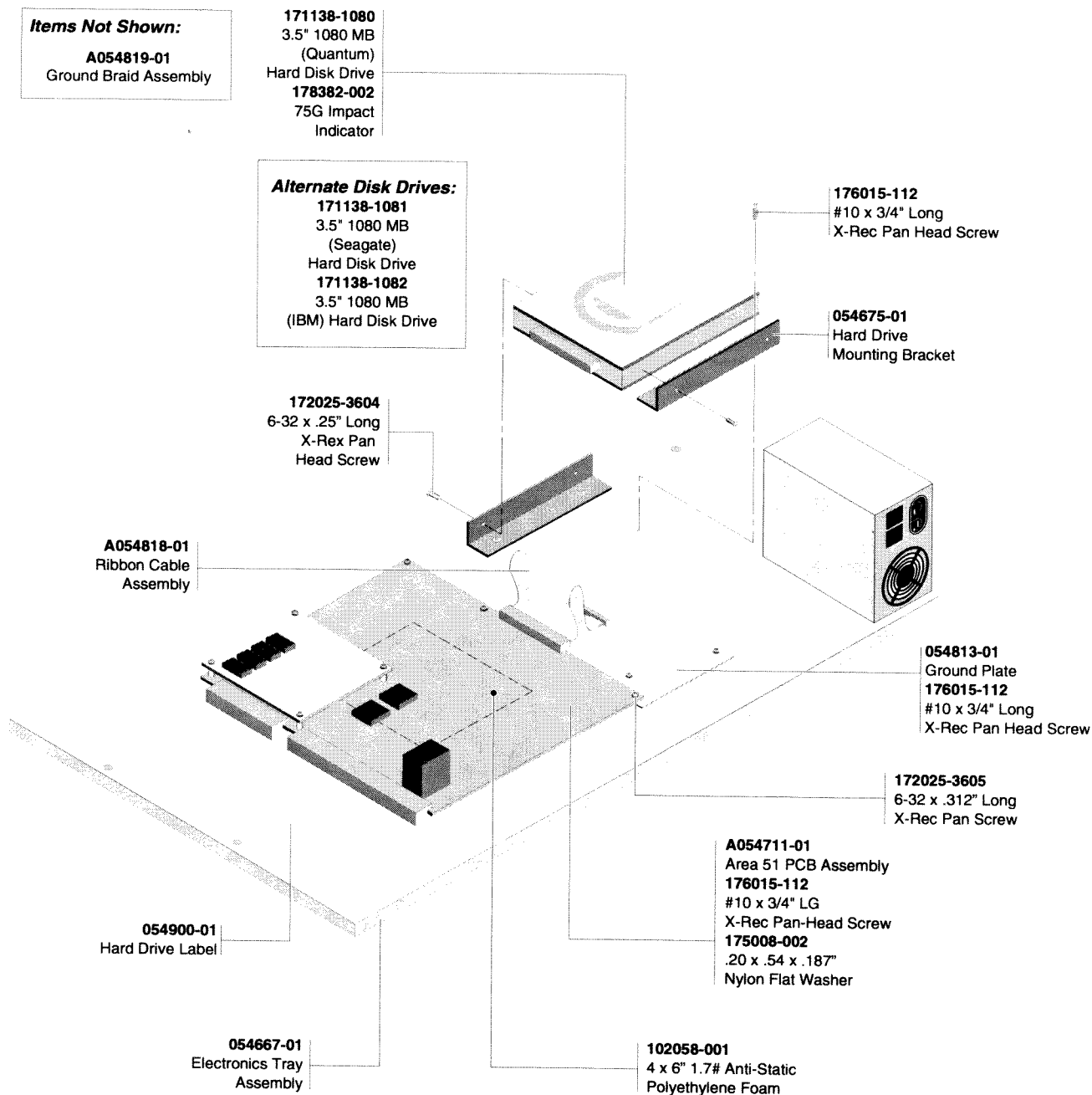

Figure 4-4 Electronics Tray Assembly

A054705-01

TOP SIDE

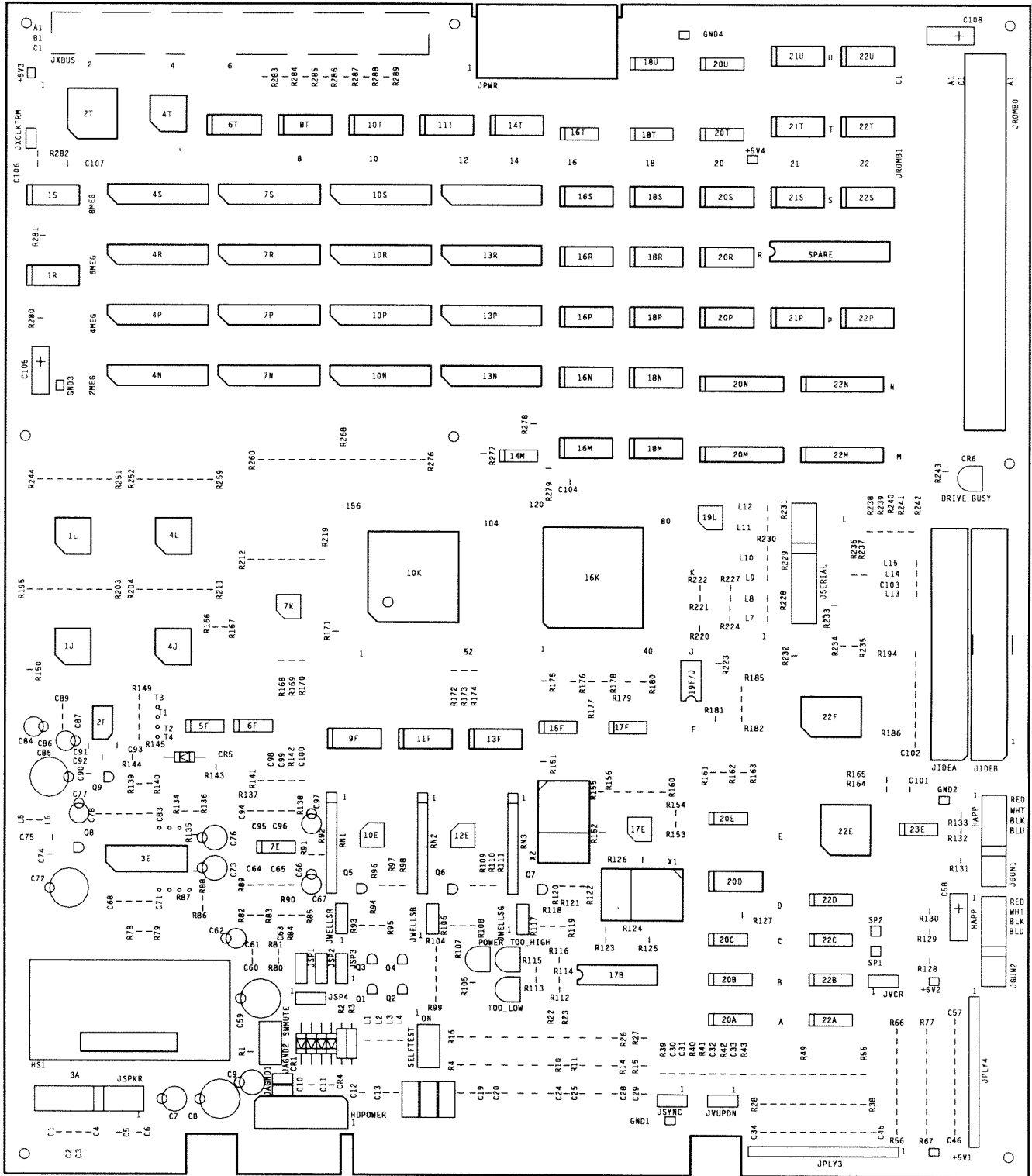

Figure 4-5 Area 51 Cojag PCB Assembly (Top Side)

A053538-02

BOTTOM SIDE

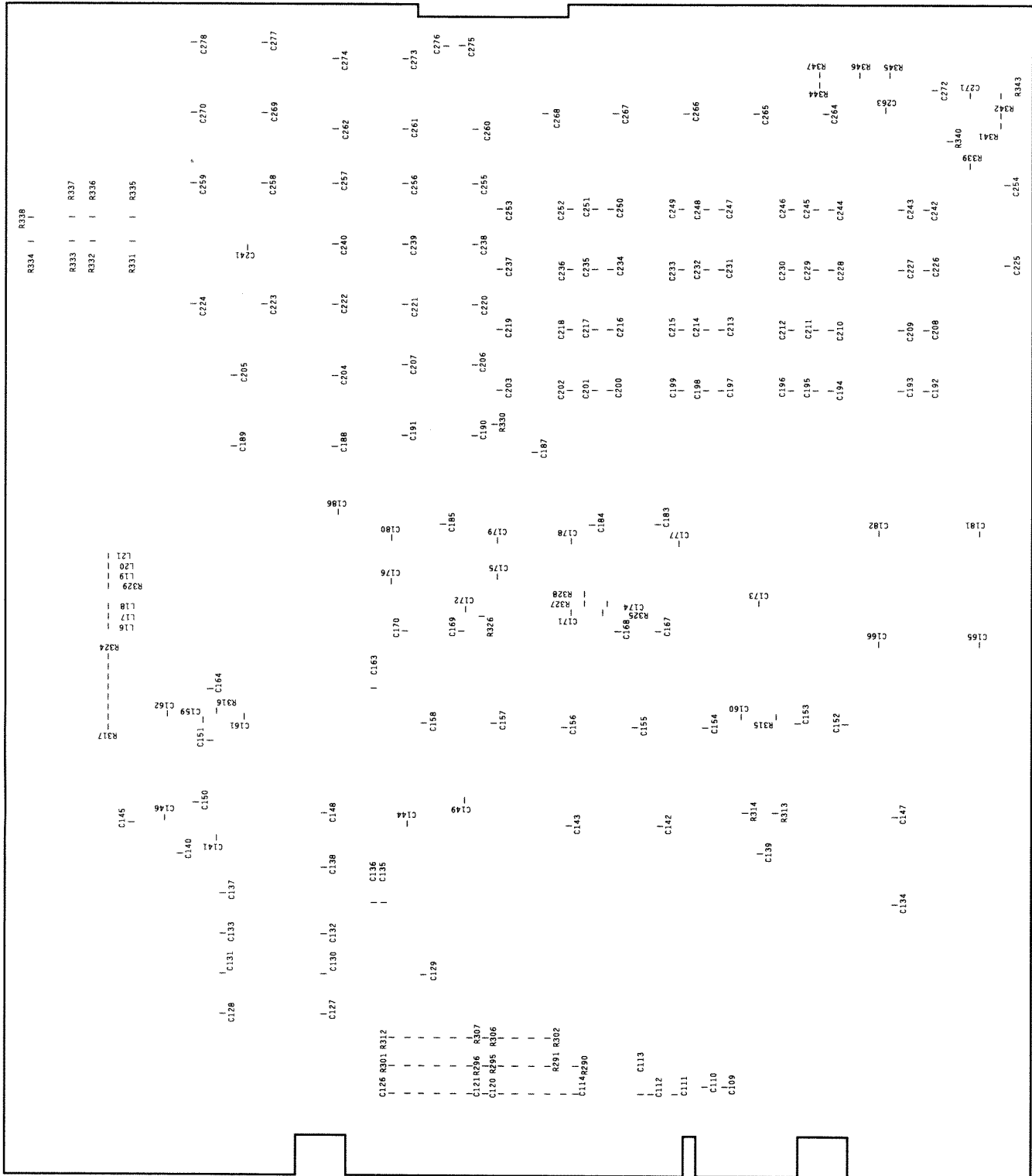

Figure 4-5 Area 51 Cojag PCB Assembly (Bottom Side)

A053538-02

Area 51 Cojag PCB Assembly Parts List

Designator	Description	Part No.	Designator	Description	Part No.
19F/J (HS1) (JSP1) (JXBUS)	Socket, 8 Pin, .300, Dbl Wipe Screw, Pan, 4-40X3/8, Xrec, Zinc Conn, Rcpt, 2-Ckt Shroud, 96 Pos, Pinless	179356-0308 172025-3206 179178-002 179369-0096	23E B	IC, 74LS14, SO14.15 Conn, Receptacle, 2-Ckt	137056-0001 179178-002
1R, 1S 2 2F 3A	IC, 74F245, SO20.3 Conn, Receptacle, 2-Ckt IC, AK4310, VSOP24 IC, TDA1554	137591-0001 179178-002 137744-002 137733-001	C1–C6 C7 C8 C9	Capacitor, Chip, 1000 pF, 50 V, Ceramic, 1206 Capacitor, 100 µF, 16 V, Electrolytic, Radial Capacitor, 1000 µF, 16 V, Electrolytic Capacitor, 100 µF, 16 V, Electrolytic, Radial	125001-0102 123013-107 123031-108 123013-107
3E 4 4N, 4P, 4R 5F, 6F	IC, TEA6320T, SO32.3 Conn, Receptacle, 2-Ckt IC, DRAM, 256KX16, 70 ns, SOJ40 IC, 74F74, SO14.15	137800-0001 179178-002 137751-070 137436-0001	C10, C11 C12 C13 C14	Capacitor, Chip, .012 µF, 50 V, Ceramic, 1206 Capacitor, Chip, .1 µF, 50 V, Ceramic, 1206 Capacitor, Chip, 1000 pF, 50 V, Ceramic, 1206 Capacitor, Chip, 100 pF, 50 V, Ceramic, 1206	125002-0123 125003-0104 125001-0102 125001-0101
6T 7E 7N, 7P, 7R 8T	IC, 74F245, SO20.3 IC, Quad Op-Amp, MC3403D, SO14.15 137673-1001 IC, DRAM, 256KX16, 70 ns, SOJ40 IC, 74F245, SO20.3	137591-0001 137673-1001 137751-070 137591-0001	C15–C17 C18–C21 C22–C25 C26–C29	Capacitor, 270PFC, 50 V, EMI Filter Capacitor, Chip, .1 µF, 50 V, Ceramic, 1206 Capacitor, Chip, .012 µF, 50 V, Ceramic, 1206 Capacitor, Chip, .1 µF, 50 V, Ceramic, 1206	140006-271 125003-0104 125002-0123 125003-0104
9F 10K 10N,10P,10R 10T	IC, 74HCT245, SO20.3 IC, CPU, Tom, QFP208 IC, DRAM, 256KX16, 70 ns, SOJ40 IC, 74F245, SO20.3	137791-0001 137785-001 137751-070 137591-0001	C30, C31 C32–C57 C58 C59	Capacitor, Chip, 1000 pF, 50 V, Ceramic, 1206 Capacitor, Chip, .1 µF, 50 V, Ceramic, 1206 Capacitor, 10 µF, 25 V, Electrolytic Capacitor, 1000 µF, 16 V, Electrolytic	125001-0102 125003-0104 124009-106 123031-108
11F 11T 13F 13N,13P,13R	IC, 74HCT245, SO20.3 IC, 74F245, SO20.3 IC, 74HCT245, SO20.3 IC, DRAM, 256KX16, 70 ns, SOJ40	137791-0001 137591-0001 137791-0001 137751-070	C60, C61 C62 C63 C64	Capacitor, Chip, .22 µF, 50 V, Ceramic, 1206 Capacitor, 1 µF, 50 V, Electrolytic, Radial Capacitor, Chip, .22 µF, 50 V, Ceramic, 1206 Capacitor, Chip, .047 µF, 50 V, Ceramic, 1206	125003-0224 123001-105 125003-0224 125002-0473
14M 14T 15F 16K	IC, 74F06, SO14.15 IC, 74F245, SO20.3 IC, 74F00, SO14.15 IC, DSP, Jerry, QFP160	137789-0001 137591-0001 137327-0001 137785-002	C65 C66 C67 C68	Capacitor, Chip, .012 µF, 50 V, Ceramic, 1206 Capacitor, Chip, .047 µF, 50 V, Ceramic, 1206 Capacitor, 1 µF, 50 V, Electrolytic, Radial Capacitor, Chip, 5600 pF, 50 V, Ceramic, 1206	125002-0123 125002-0473 125002-0473 123001-105 125002-0562
16M 16P, 16S 17B 17F	IC, 74F273, SO20.3 IC, 74F245, SO20.3 IC, LM613 IC, 74F02, SO14.15	137610-1001 137591-0001 137746-001 137481-0001			
18M,18P,18S 20A, 20B 20C 20D	IC, 74F245, SO20.3 IC, 74LS257, SO16.15 IC, 74F06, SO14.15 IC, 74LS273, SO20.3	137591-0001 137136-0001 137789-0001 137040-0001			
20E 20P,20R,20S 22A, 22B, 22C, 22D 22F	IC, 74F32, SO14.15 IC, 74F245, SO20.3 IC, 74LS257, SO16.15 IC, VT83C461, QFP100	137486-0001 137591-0001 137136-0001 137799-0001			

**Area 51 Cojag PCB Assembly
Parts List, Continued**

Designator	Description	Part No.	Designator	Description	Part No.
C69	Capacitor, Chip, .033 μF, 50 V, Ceramic, 1206	125002-0333	C102	Capacitor, Chip, .1 μF, 50 V, Ceramic, 1206	125003-0104
C70	Capacitor, Chip, .22 μF, 50 V, Ceramic, 1206	125003-0224	C103	Capacitor, Chip, 100 pF, 50 V, Ceramic, 1206	125001-0101
C71	Capacitor, Chip, .150 μF, 50 V, Ceramic, 1206	125003-0154	C104	Capacitor, Chip, .1 μF, 50 V, Ceramic, 1206	125003-0104
C72	Capacitor, 1000 μF, 16 V, Electrolytic	123031-108	C105	Capacitor, 10 μF, 25 V, Electrolytic	124009-106
C73	Capacitor, 100 μF, 35 V, Electrolytic, Radial	123009-1014	C106	Capacitor, Chip, 47 pF, 50 V, Ceramic, 1206	125001-0470
C74, C75	Capacitor, Chip, .33 μF, 50 V, Ceramic, 1206	125003-0334	C108	Capacitor, 10 μF, 25 V, Electrolytic	124009-106
C76	Capacitor, 47 μF, 50 V, Electrolytic	123015-476	C109, C110	Capacitor, Chip, .012 μF, 50 V, Ceramic, 1206	125002-0123
C77	Capacitor, 10 μF, 35 V, Electrolytic, Radial	123000-106	C111	Capacitor, Chip, .1 μF, 50 V, Ceramic, 1206	125003-0104
C78, C79	Capacitor, Chip, .1 μF, 50 V, Ceramic, 1206	125003-0104	C112	Capacitor, Chip, 1000 pF, 50 V, Ceramic, 1206	125001-0102
C80	Capacitor, Chip, 5600 pF, 50 V, Ceramic, 1206	125002-0562	C113	Capacitor, Chip, 100 pF, 50 V, Ceramic, 1206	125001-0101
C81	Capacitor, Chip, .033 μF, 50 V, Ceramic, 1206	125002-0333	C114	Capacitor, Chip, 1000 pF, 50 V, Ceramic, 1206	125001-0102
C82	Capacitor, Chip, 8200 pF, 50 V, Ceramic, 1206	125002-0822	C115–C117	Capacitor, Chip, .1 μF, 50 V, Ceramic, 1206	125003-0104
C83	Capacitor, Chip, .150 μF, 50 V, Ceramic, 1206	125003-0154	C118–C121	Capacitor, Chip, .012 μF, 50 V, Ceramic, 1206	125002-0123
C84	Capacitor, 10 μF, 35 V, Electrolytic, Radial	123000-106	C122–C133	Capacitor, Chip, .1 μF, 50 V, Ceramic, 1206	125003-0104
C85	Capacitor, 1000 μF, 16 V, Electrolytic	123031-108	C134	Capacitor, Chip, 8200 pF, 50 V, Ceramic, 1206	125002-0822
C86	Capacitor, 10 μF, 35 V, Electrolytic, Radial	123000-106	C135	Capacitor, Chip, .012 μF, 50 V, Ceramic, 1206	125002-0123
C87	Capacitor, Chip, .1 μF, 50 V, Ceramic, 1206	125003-0104	C136–C146	Capacitor, Chip, .1 μF, 50 V, Ceramic, 1206	125003-0104
C88, C89	Capacitor, Chip, .22 μF, 50 V, Ceramic, 1206	125003-0224	C147	Capacitor, Chip, .22 μF, 50 V, Ceramic, 1206	125003-0224
C90	Capacitor, Chip, .33 μF, 50 V, Ceramic, 1206	125003-0334	C148–C158, C161–C171, C173, C175–C278	Capacitor, Chip, .1 μF, 50 V, Cer., 1206	125003-0104
C91	Capacitor, Chip, .1 μF, 50 V, Ceramic, 1206	125003-0104	CR1–CR4	Diode, 1N4001	131048-001
C92	Capacitor, Chip, .33 μF, 50 V, Ceramic, 1206	125003-0334	CR5	Diode, 1N5818	131025-001
C93	Capacitor, Chip, .1 μF, 50 V, Ceramic, 1206	125003-0104	CR6	LED, Yel, T1-3/4, Diffused, 25-MCD, 40-Deg	138016-001
C94–C96	Capacitor, Chip, .047 μF, 50 V, Ceramic, 1206	125002-0473	(G)	Conn, Receptacle, 2-Ckt	179178-002
C97	Capacitor, 1 μF, 50 V, Electrolytic, Radial	123001-105	GND1–4	Test Point	179051-001
C98–C100	Capacitor, Chip, .047 μF, 50 V, Ceramic, 1206	125002-0473	HDPOWER	Conn, 4-Ckt, Hdr, .200 Ctr	179310-004
			HS1	Heat Sink, Alum, 2X2X1, 2X4-40	178378-001
			JGUN1, 2	Conn, 9-Ckt, Hdr, .100 Ctr, Key 6	179118-009
			JIDEB	Conn, 40-Ckt, Hdr, 2X20, Low Prof.	179261-040

Area 51 Cojag PCB Assembly Parts List, Continued

Designator	Description	Part No.	Designator	Description	Part No.
JPLY3, 4	Conn, 15-Ckt, Hdr, .100 Ctr	179118-015	R93	Resistor, Chip, 12 Ω , $\pm 5\%$, 1/8 W, 1206	112006-0120
JPWR	Conn, 9-Ckt, Hdr, .156 Ctr, Rt, Key 3	179165-009	R94	Resistor, Chip, 10 Ω , $\pm 5\%$, 1/8 W, 1206	112006-0100
JSP1-JSP4	Conn, 3-Ckt; Hdr, .100 Ctr	179048-003	R95	Resistor, Chip, 75 Ω , $\pm 5\%$, 1/8 W, 1206	112006-0750
JSPKR	Conn, 11-Ckt, Hdr, .100 Ctr, Key 5	179118-011	R96	Resistor, Chip, 100 Ω , $\pm 5\%$, 1/8 W, 1206	112006-0101
JSYNC	Conn, 3-Ckt, Hdr, .100 Ctr	179048-003	R97	Resistor, Chip, 1 K Ω , $\pm 5\%$, 1/8 W, 1206	112006-0102
JVCR	Conn, 3-Ckt, Hdr, .100 Ctr	179048-003	R98	Resistor, Chip, 2.4 K Ω , $\pm 5\%$, 1/8 W, 1206	112006-0242
JVUPDN	Conn, 3-Ckt, Hdr, .100 Ctr	179048-003	R99-R104	Resistor, Chip, 1 K Ω , $\pm 5\%$, 1/8 W, 1206	112006-0102
JWELLSB	Conn, 3-Ckt, Hdr, .100 Ctr	179048-003	R105	Resistor, Chip, 470 Ω , $\pm 5\%$, 1/8 W, 1206	112006-0471
JWELLSG	Conn, 3-Ckt, Hdr, .100 Ctr	179048-003	R106	Resistor, Chip, 12 Ω , $\pm 5\%$, 1/8 W, 1206	112006-0120
JWELLSR	Conn, 3-Ckt, Hdr, .100 Ctr	179048-003	R107	Resistor, Chip, 10 Ω , $\pm 5\%$, 1/8 W, 1206	112006-0100
JWELLSR	Conn, Receptacle, 2-Ckt	179178-002	R108	Resistor, Chip, 75 Ω , $\pm 5\%$, 1/8 W, 1206	112006-0750
JXBUS	Conn, 96-Ckt, Recep., Pressfit, Long	179368-0096	R109	Resistor, Chip, 100 Ω , $\pm 5\%$, 1/8 W, 1206	112006-0101
JXCLKTRM	Conn, 2-Ckt, Hdr, .100 Ctr	179048-002	R110	Resistor, Chip, 1 K Ω , $\pm 5\%$, 1/8 W, 1206	112006-0102
L1-L6	Inductor, Ferrite Bead, 1206	141032-0001	R111	Resistor, Chip, 2.4 K Ω , $\pm 5\%$, 1/8 W, 1206	112006-0242
L13-L21	Inductor, 600 Ω , 1206	141032-0002	R112	Resistor, Chip, 20 Ω , $\pm 1\%$, 1/8 W, 1206	112002-0200
POWER	LED, Grn, MV5453, T1-3/4, 20-MCD, Wide	138020-001	R113	Resistor, Chip, 470 Ω , $\pm 5\%$, 1/8 W, 1206	112006-0471
Q1-Q4	Transistor, 2N5306	133033-001	R114	Resistor, Chip, 1 K Ω , $\pm 5\%$, 1/8 W, 1206	112006-0102
Q5-Q7	Transistor, 2N3904	133041-001	R115	Resistor, Chip, 470 Ω , $\pm 5\%$, 1/8 W, 1206	112006-0471
Q8	IC, 78L09	137740-002	R116	Resistor, Chip, 1 K Ω , $\pm 5\%$, 1/8 W, 1206	112006-0102
Q9	IC, 78L05	137258-001	R117	Resistor, Chip, 12 Ω , $\pm 5\%$, 1/8 W, 1206	112006-0120
R1	Resistor, Chip, 1 K Ω , $\pm 5\%$, 1/8 W, 1206	112006-0102	R118	Resistor, Chip, 10 Ω , $\pm 5\%$, 1/8 W, 1206	112006-0100
R2, R3	Resistor, 0 Ω , $\pm 5\%$, 1/4 W	110005-001	R119	Resistor, Chip, 75 Ω , $\pm 5\%$, 1/8 W, 1206	112006-0750
R4, R5	Resistor, Chip, 470 Ω , $\pm 5\%$, 1/8 W, 1206	112006-0471	R120	Resistor, Chip, 100 Ω , $\pm 5\%$, 1/8 W, 1206	112006-0101
R6	Resistor, Chip, 1 K Ω , $\pm 5\%$, 1/8 W, 1206	112006-0102	R121	Resistor, Chip, 1 K Ω , $\pm 5\%$, 1/8 W, 1206	112006-0102
R7-R15	Resistor, Chip, 470 Ω , $\pm 5\%$, 1/8 W, 1206	112006-0471	R122	Resistor, Chip, 2.4 K Ω , $\pm 5\%$, 1/8 W, 1206	112006-0242
R16-R27	Resistor, Chip, 1 K Ω , $\pm 5\%$, 1/8 W, 1206	112006-0102	R123-R125	Resistor, Chip, 39 K Ω , $\pm 5\%$, 1/8 W, 1206	112006-0393
R28-R40	Resistor, Chip, 470 Ω , $\pm 5\%$, 1/8 W, 1206	112006-0471	R126	Resistor, Chip, 0 Ω , $\pm 5\%$, 1/8 W, 1206	112006-0001
R41-R66	Resistor, Chip, 1 K Ω , $\pm 5\%$, 1/8 W, 1206	112006-0102	R127	Resistor, Chip, 330 Ω , $\pm 5\%$, 1/8 W, 1206	112006-0331
R67-R75	Resistor, Chip, 470 Ω , $\pm 5\%$, 1/8 W, 1206	112006-0471	R128	Resistor, Chip, 1 K Ω , $\pm 5\%$, 1/8 W, 1206	112006-0102
R76	Resistor, Chip, 1 K Ω , $\pm 5\%$, 1/8 W, 1206	112006-0102	R129	Resistor, Chip, 330 Ω , $\pm 5\%$, 1/8 W, 1206	112006-0331
R77	Resistor, Chip, 470 Ω , $\pm 5\%$, 1/8 W, 1206	112006-0471	R130, R131	Resistor, Chip, 1 K Ω , $\pm 5\%$, 1/8 W, 1206	112006-0102
R78	Resistor, Chip, 20 K Ω , $\pm 5\%$, 1/8 W, 1206	112006-0203	R132	Resistor, Chip, 330 Ω , $\pm 5\%$, 1/8 W, 1206	112006-0331
R79	Resistor, Chip, 2.2 K Ω , $\pm 5\%$, 1/8 W, 1206	112006-0222	R133	Resistor, Chip, 1 K Ω , $\pm 5\%$, 1/8 W, 1206	112006-0102
R80, R81	Resistor, Chip, 100 K Ω , $\pm 1\%$, 1/8 W, 1206	112002-1003	R134	Resistor, Chip, 100 K Ω , $\pm 1\%$, 1/8 W, 1206	112002-1003
R82-R84	Resistor, Chip, 45.3 K Ω , $\pm 1\%$, 1/8 W, 1206	112002-4532	R137, R138	Resistor, Chip, 11.0 K Ω , $\pm 1\%$, 1/8 W, 1206	112002-1102
R85	Resistor, Chip, 10 K Ω , $\pm 5\%$, 1/8 W, 1206	112006-0103	R139	Resistor, Chip, 20 K Ω , $\pm 5\%$, 1/8 W, 1206	112006-0203
R88	Resistor, Chip, 100 K Ω , $\pm 1\%$, 1/8 W, 1206	112002-1003	R140	Resistor, Chip, 2.2 K Ω , $\pm 5\%$, 1/8 W, 1206	112006-0222
R89	Resistor, Chip, 47 K Ω , $\pm 5\%$, 1/8 W, 1206	112006-0473	R141, R142	Resistor, Chip, 22.6 K Ω , $\pm 1\%$, 1/8 W, 1206	112002-2262
R90	Resistor, Chip, 22.6 K Ω , $\pm 1\%$, 1/8 W, 1206	112002-2262	R143	Resistor, Chip, 330 Ω , $\pm 5\%$, 1/8 W, 1206	112006-0331
R91, R92	Resistor, Chip, 45.3 K Ω , $\pm 1\%$, 1/8 W, 1206	112002-4532	R144	Resistor, Chip, 10 Ω , $\pm 5\%$, 1/8 W, 1206	112006-0100
			R145-R149	Resistor, Chip, 47 Ω , $\pm 5\%$, 1/8 W, 1206	112006-0470
			R150	Resistor, Chip, 220 Ω , $\pm 5\%$, 1/8 W, 1206	112006-0221
			R151	Resistor, Chip, 2.2 K Ω , $\pm 5\%$, 1/8 W, 1206	112006-0222

**Area 51 Cojag PCB Assembly
Parts List, Continued**

Designator	Description	Part No.	Designator	Description	Part No.
R152–R155, R158–R160	Resistor, Chip, 33 Ω, ±5%, 1/8 W, 1206	112006-0330	R278, R279	Resistor, Chip, 330 Ω, ±5%, 1/8 W, 1206	112006-0331
R161–R163, R165	Resistor, Chip, 10 KΩ, ±5%, 1/8 W, 1206	112006-0103	R280	Resistor, Chip, 2 KΩ, ±5%, 1/8 W, 1206	112006-0202
R166, R167	Resistor, Chip, 2.2 KΩ, ±5%, 1/8 W, 1206	112006-0222	R281	Resistor, Chip, 4.7 KΩ, ±5%, 1/8 W, 1206	112006-0472
R168–R170	Resistor, Chip, 33 Ω, ±5%, 1/8 W, 1206	112006-0330	R282	Resistor, Chip, 47 Ω, ±5%, 1/8 W, 1206	112006-0470
R172	Resistor, Chip, 2 KΩ, ±5%, 1/8 W, 1206	112006-0202	R286	Resistor, Chip, 10 Ω, ±5%, 1/8 W, 1206	112006-0100
R173	Resistor, Chip, 1 KΩ, ±5%, 1/8 W, 1206	112006-0102	R287–R289	Resistor, Chip, 4.7 KΩ, ±5%, 1/8 W, 1206	112006-0472
R174	Resistor, Chip, 2 KΩ, ±5%, 1/8 W, 1206	112006-0202	R290–R301	Resistor, Chip, 470 Ω, ±5%, 1/8 W, 1206	112006-0471
R175, R176	Resistor, Chip, 10 KΩ, ±5%, 1/8 W, 1206	112006-0103	R302–R312	Resistor, Chip, 1 KΩ, ±5%, 1/8 W, 1206	112006-0102
R177, R178	Resistor, Chip, 2.2 KΩ, ±5%, 1/8 W, 1206	112006-0222	R313, R314	Resistor, Chip, 45.3 KΩ, ±1%, 1/8 W, 1206	112002-4532
R179	Resistor, Chip, 330, ±5%, 1/8 W, 1206	112006-0331	R317–R324	Resistor, Chip, 47 Ω, ±5%, 1/8 W, 1206	112006-0470
R180	Resistor, Chip, 1 KΩ, ±5%, 1/8 W, 1206	112006-0102	R325	Resistor, Chip, 1 KΩ, ±5%, 1/8 W, 1206	112006-0102
R181	Resistor, Chip, 10 KΩ, ±5%, 1/8 W, 1206	112006-0103	R329	Resistor, Chip, 100 Ω, ±5%, 1/8 W, 1206	112006-0101
R182, R183	Resistor, Chip, 1.2 KΩ, ±5%, 1/8 W, 1206	112006-0122	R330	Resistor, Chip, 470, ±5%, 1/8 W, 1206	112006-0471
R184	Resistor, Chip, 100 Ω, ±5%, 1/8 W, 1206	112006-0101	R340	Resistor, Chip, 4.7 KΩ, ±5%, 1/8 W, 1206	112006-0472
R185	Resistor, Chip, 4.7 KΩ, ±5%, 1/8 W, 1206	112006-0472	R341	Resistor, Chip, 2 KΩ, ±5%, 1/8 W, 1206	112006-0202
R186	Resistor, Chip, 100 Ω, ±5%, 1/8 W, 1206	112006-0101	R342	Resistor, Chip, 1 KΩ, ±5%, 1/8 W, 1206	112006-0102
R187–R194	Resistor, Chip, 47 Ω, ±5%, 1/8 W, 1206	112006-0470	R343	Resistor, Chip, 10 KΩ, ±5%, 1/8 W, 1206	112006-0103
R195	Resistor, Chip, 220 Ω, ±5%, 1/8 W, 1206	112006-0221	R344–R347	Resistor, Chip, 22 Ω, ±5%, 1/8 W, 1206	112006-0220
R196–R219	Resistor, Chip, 33 Ω, ±5%, 1/8 W, 1206	112006-0330	RN1–RN3	Resistor Network, R2R10, 1K/2 KΩ, SIP10	118015-001
R220	Resistor, Chip, 1 KΩ, ±5%, 1/8 W, 1206	112006-0102	SELFTEST	Switch, Slide, SPDT	160040-001
R221, R222, R224–R232	Resistor, Chip, 10 KΩ, ±5%, 1/8 W, 1206	112006-0103	SPARE	Socket, 24 Pin, .300, Dbl Wipe	179356-0324
R233	Resistor, Chip, 1 KΩ, ±5%, 1/8 W, 1206	112006-0102	TOO_HIGH	LED, Red, T1-3/4, Diffused, .5MCD, 80-Deg	138021-001
R234	Resistor, Chip, 10 KΩ, ±5%, 1/8 W, 1206	112006-0103	TOO_LOW	LED, Red, T1-3/4, Diffused, .5MCD, 80-Deg	138021-001
R235	Resistor, Chip, 4.7 KΩ, ±5%, 1/8 W, 1206	112006-0472	X1	Crystal, 52.000 MHz, Osc. Module, .3X.6DIP	144008-012
R236	Resistor, Chip, 300 Ω, ±5%, 1/8 W, 1206	112006-0301	X2	Crystal, 14.318 MHz, Osc. Module	144008-001
R237	Resistor, Chip, 4.7 KΩ, ±5%, 1/8 W, 1206	112006-0472	HS1	COMPOUND, THERMAL	107031-001
R238–R242	Resistor, Chip, 10 KΩ, ±5%, 1/8 W, 1206	112006-0103			
R243	Resistor, Chip, 470 Ω, ±5%, 1/8 W, 1206	112006-0471			
R252–R264	Resistor, Chip, 33 Ω, ±5%, 1/8 W, 1206	112006-0330			
R265–R267	Resistor, Chip, 10 KΩ, ±5%, 1/8 W, 1206	112006-0103			
R268–R271	Resistor, Chip, 33 Ω, ±5%, 1/8 W, 1206	112006-0330			
R272–R276	Resistor, Chip, 10 KΩ, ±5%, 1/8 W, 1206	112006-0103			
R277	Resistor, Chip, 220 Ω, ±5%, 1/8 W, 1206	112006-0221			

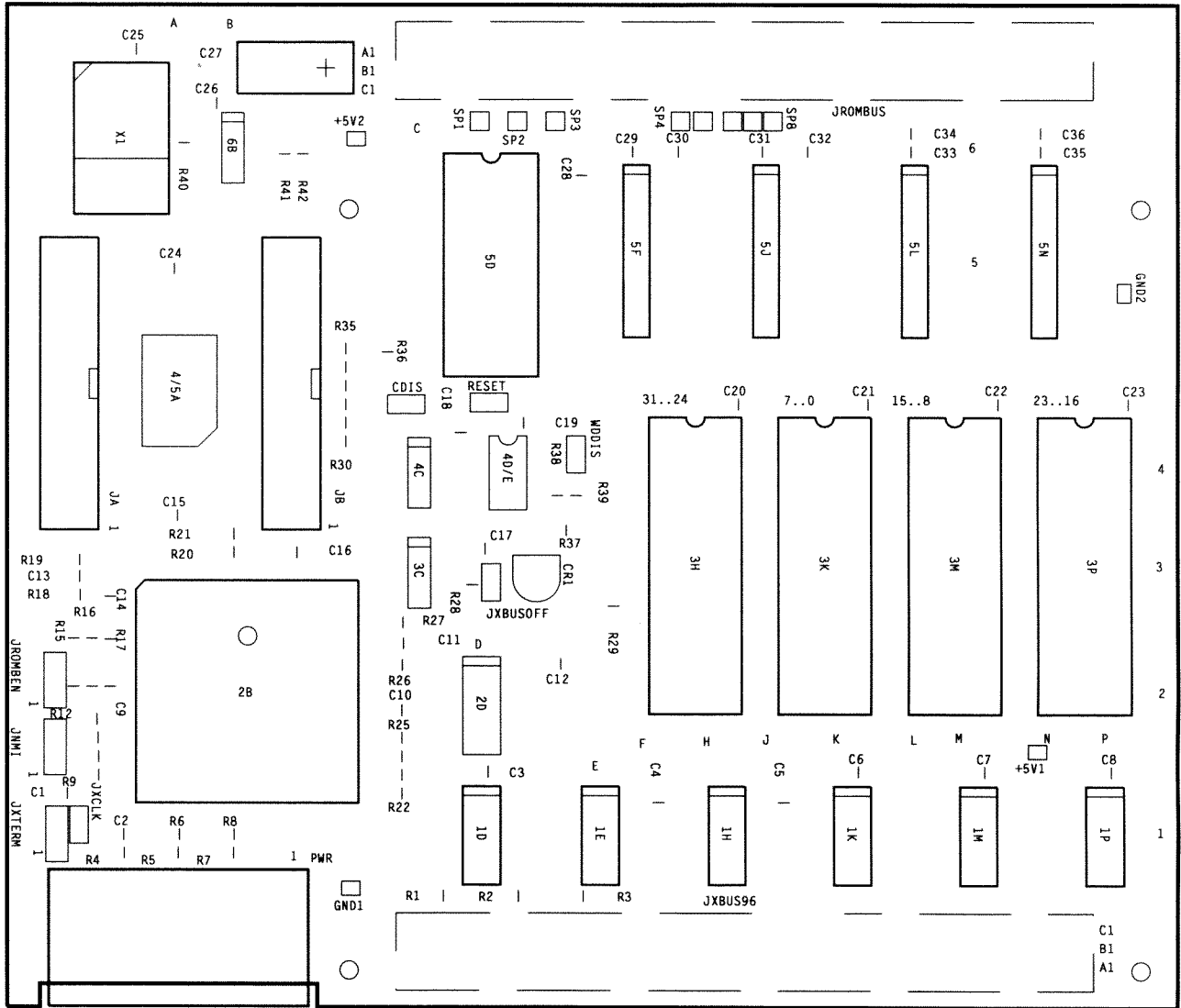

Figure 4-6 Area 51 EC20X32 PCB Assembly

A053448-02

Area 51 EC20X32 PCB Assembly Parts List

Designator	Description	Part No.	Designator	Description	Part No.
2B	Socket, 68 Pin, PGA for 68PLCC IC	179237-068	GND1, 2	Test Point	179051-001
3H, 3K, 3M, 3P	Socket, 32 Pin, .600, Dbl Wipe	179356-0632	JXBUS96	Conn, 96 Ckt, Rcpt, Pressfit, Short	179368-0196
5D	Socket, 24 Pin, .600 Dbl Wipe	179356-0624	PWR	Conn, 9 Ckt, Hdr, .156 Ctr, Rt, Key 3	179165-009
1D, 1E, 1H, 1K, 1M, 1P, 2D	IC, 74F245, SO20.3	137591-0001	R1-R3	Resistor, Chip, 2.2 K Ω , \pm 5%, 1/8 W, 1206	112006-0222
3C	IC, 74F04, SO14.15	137437-0001	R4	Resistor, Chip, 1 K Ω , \pm 5%, 1/8 W, 1206	112006-0102
4/5A	IC, CPU, 68EC020, 25 MHz, 100PQFP	137691-025	R5	Resistor, Chip, 220 Ω , \pm 5%, 1/8 W, 1206	112006-0221
4D/E	IC, DS1232	137762-001	R6-R8	Resistor, Chip, 1 K Ω , \pm 5%, 1/8 W, 1206	112006-0102
5D	IC, RAM, 48T02, Battery W/Clock	137540-150	R10	Resistor, Chip, 10 K Ω , \pm 5%, 1/8 W, 1206	112006-0103
5F,5J,5L,5N	IC, SRAM, 32KX8, 20 ns, SOJ28.3	137670-1020	R11	Resistor, Chip, 22 Ω , \pm 5%, 1/8 W, 1206	112006-0220
6B	IC, 74F74, SO14.15	137436-0001	R12-R14	Resistor, Chip, 10 K Ω , \pm 5%, 1/8 W, 1206	112006-0103
C2-C12, C15-C26	Capacitor, Chip, .1 μ F, 50 V, Cer., 1206	125003-0104	R15, R16	Resistor, Chip, 22 Ω , \pm 5%, 1/8 W, 1206	112006-0220
C27	Capacitor, 100 μ F, 16 V, Electro., Axial	124008-107	R19	Resistor, Chip, 10 K Ω , \pm 5%, 1/8 W, 1206	112006-0103
C28, C29	Capacitor, Chip, .1 μ F, 50 V, Cer., 1206	125003-0104	R20	Resistor, Chip, 10 Ω , \pm 5%, 1/8 W, 1206	112006-0100
C30	Capacitor, Chip, .012 μ F, 50 V, Cer., 1206	125002-0123	R22-R26	Resistor, Chip, 22 Ω , \pm 5%, 1/8 W, 1206	112006-0220
C31	Capacitor, Chip, .1 μ F, 50 V, Cer., 1206	125003-0104	R27	Resistor, Chip, 1 K Ω , \pm 5%, 1/8 W, 1206	112006-0102
C32	Capacitor, Chip, .012 μ F, 50 V, Cer., 1206	125002-0123	R28	Resistor, Chip, 10 K Ω , \pm 5%, 1/8 W, 1206	112006-0103
C33	Capacitor, Chip, .1 μ F, 50 V, Cer., 1206	125003-0104	R29	Resistor, Chip, 10 Ω , \pm 5%, 1/8 W, 1206	112006-0100
C34	Capacitor, Chip, .012 μ F, 50 V, Cer., 1206	125002-0123	R30	Resistor, Chip, 10 K Ω , \pm 5%, 1/8 W, 1206	112006-0103
C35	Capacitor, Chip, .1 μ F, 50 V, Cer., 1206	125003-0104	R31	Resistor, Chip, 1 K Ω , \pm 5%, 1/8 W, 1206	112006-0102
C36	Capacitor, Chip, .012 μ F, 50 V, Cer., 1206	125002-0123	R32	Resistor, Chip, 10 K Ω , \pm 5%, 1/8 W, 1206	112006-0103
CR1	LED, Grn, MV5453, T1-3/4, 20-MCD, Wide	138020-001	R35	Resistor, Chip, 1 K Ω , \pm 5%, 1/8 W, 1206	112006-0102
			R36	Resistor, Chip, 10 K Ω , \pm 5%, 1/8 W, 1206	112006-0103
			R37-R39	Resistor, Chip, 1 K Ω , \pm 5%, 1/8 W, 1206	112006-0102
			R40-R42	Resistor, Chip, 22 Ω , \pm 5%, 1/8 W, 1206	112006-0220
			X1	Crystal, 50.000 MHz, Osc. Module	144008-005



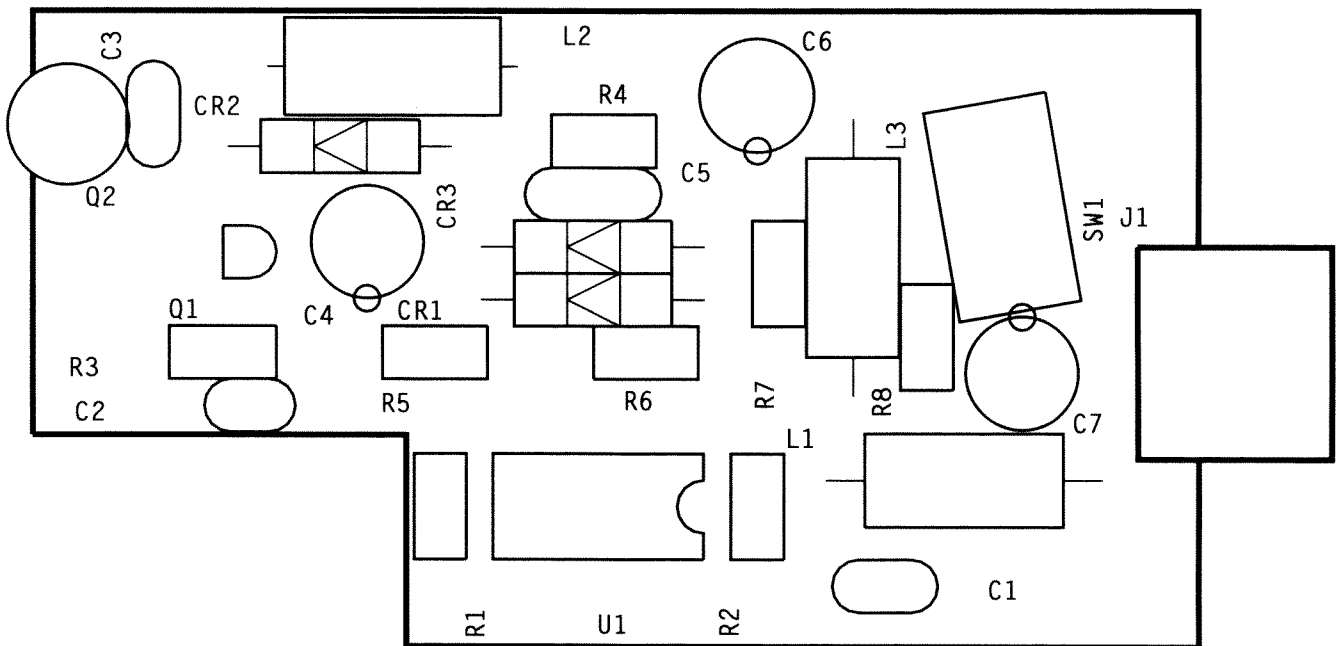

Figure 4-7 Area 51 Gun PCB Assembly

A051987-01

Area 51 Gun PCB Assembly Parts List

Designator	Description	Part No.	Designator	Description	Part No.
C2	CAP, .01 μ F, 50V, \pm 10%, CER	122015-103	L1,L3	INDUCTOR, FERRITE BEAD, N12N	141003-005
C1,C3	CAP, .1 μ F, 50V, +80%-20%, CER	122002-104	L2	INDUCTOR, 5.6 μ H	141016-562
C5	CAP, 1000 PF, 100V, \pm 5%, CER	122016-102	R2	RES, 100K Ω , \pm 5%, 1/8W	110027-104
C4,C6,C7	CAP, 22 μ F, 16V, \pm 10%, TANTALUM, RADIAL	127003-226	R1	RES, 150K Ω , \pm 5%, 1/8W	110027-154
J1	CONN, 4 CKT, HDR, .100 CTR, RT-ANGLE	179165-004	R4,R7	RES, 1K Ω , \pm 5%, 1/8W	110027-102
CR1-CR3	DIODE, 1N914	131052-001	R5	RES, 200K Ω , \pm 5%, 1/8W	110027-204
U1	IC, LM311	137687-001	R3	RES, 24K Ω , \pm 5%, 1/8W	110027-243
			R8	RES, 47 Ω , \pm 5%, 1/8W	110027-470
			R6	RES, 47K Ω , \pm 5%, 1/8W	110027-473
			Q1	TRANS, 2N3904	133041-001
			Q2	TRANS, MRD300, TO18	133038-001

N O T E S

Schematic Diagrams

INTRODUCTION

THIS CHAPTER contains schematic diagrams for various parts of the Area 51™ game, including the gun assembly. In addition, this chapter includes wiring diagrams for the entire game and the coin door. The PCB *assembly drawings* are illustrated in Chapter 4, Parts Illustrations.



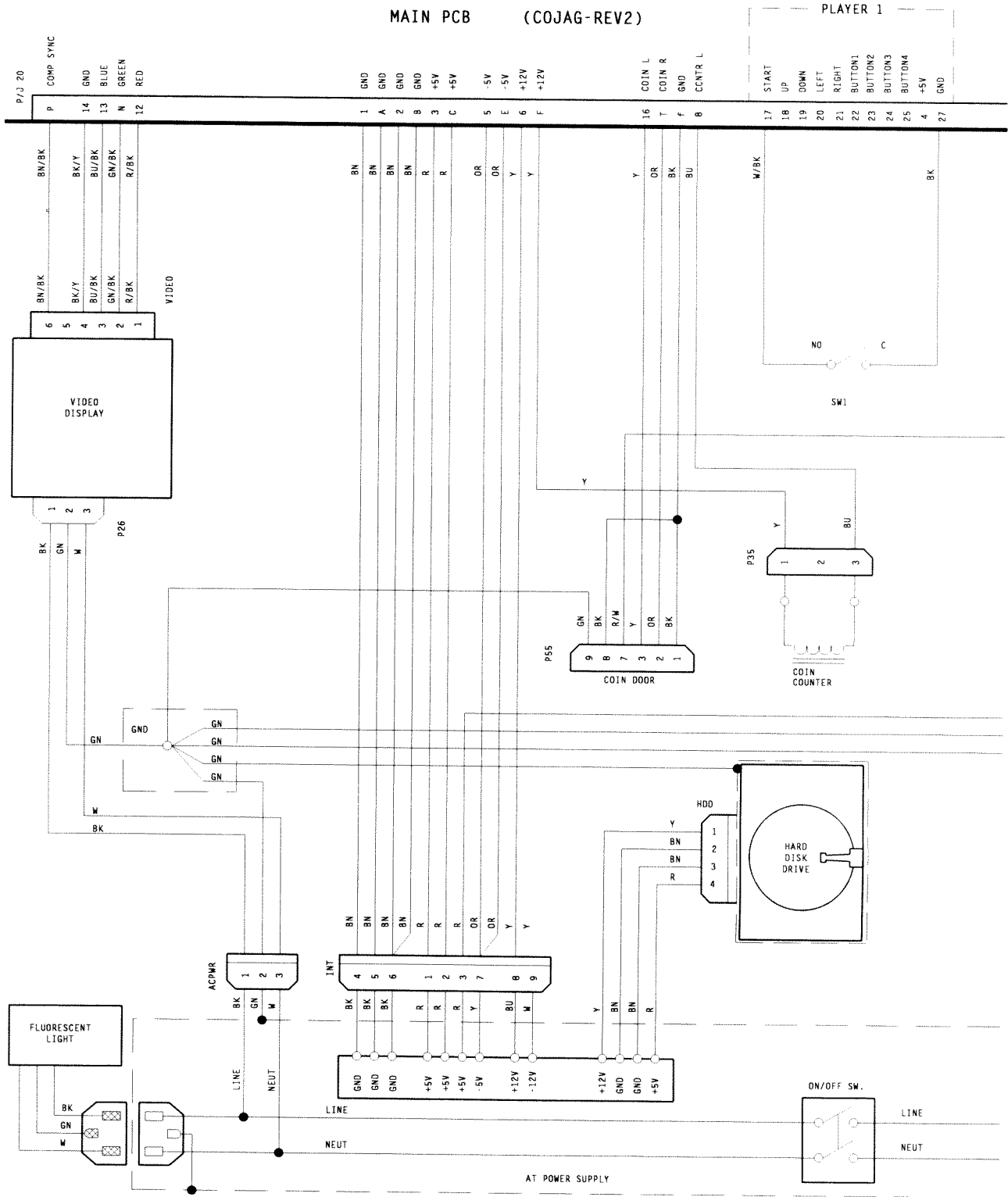

Figure 5-1 Area 51 Game Wiring Diagram

054644-01 Rev. A

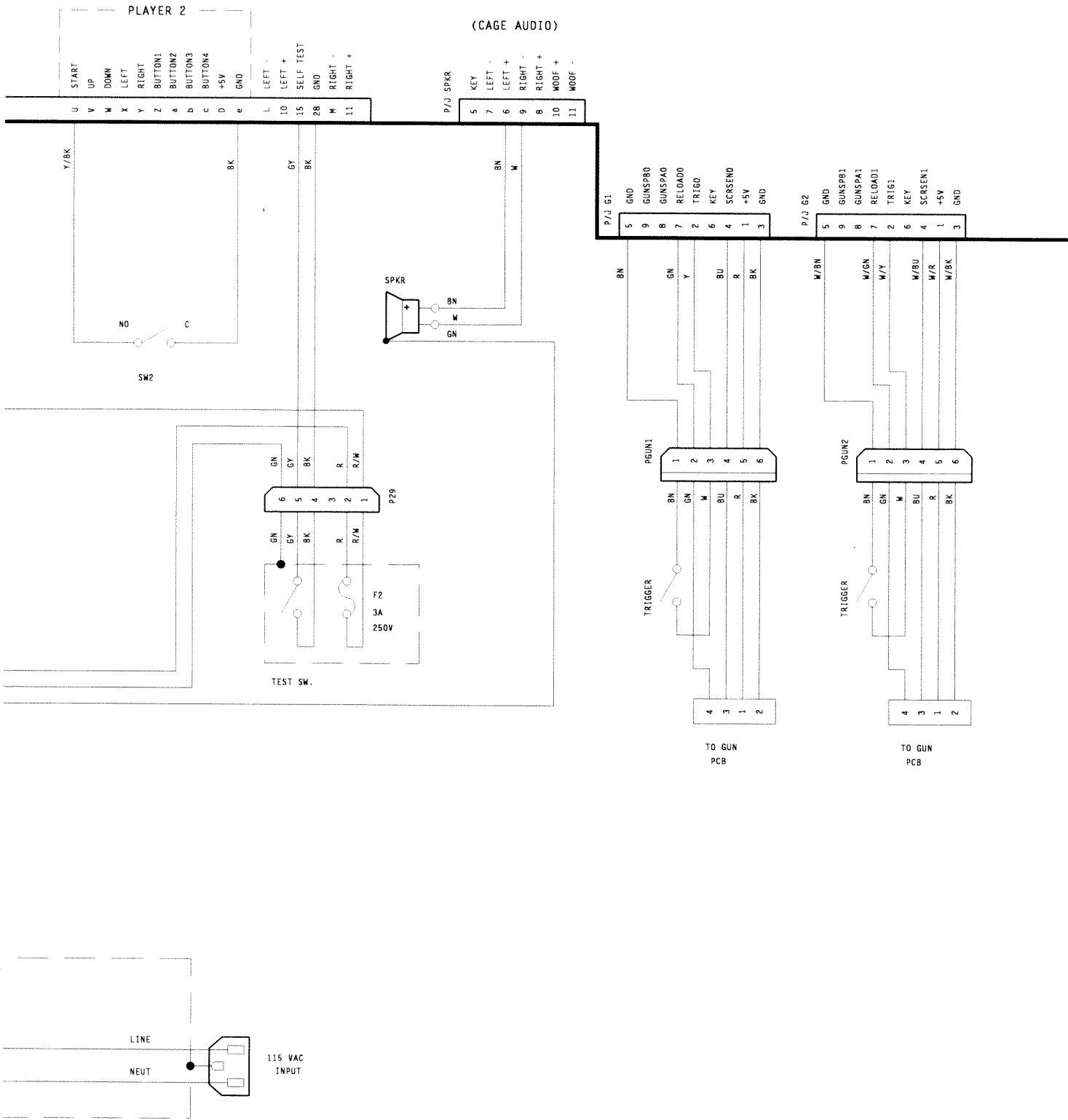

Figure 5-1 Area 51 Game Wiring Diagram, Continued

054644-01 Rev. A

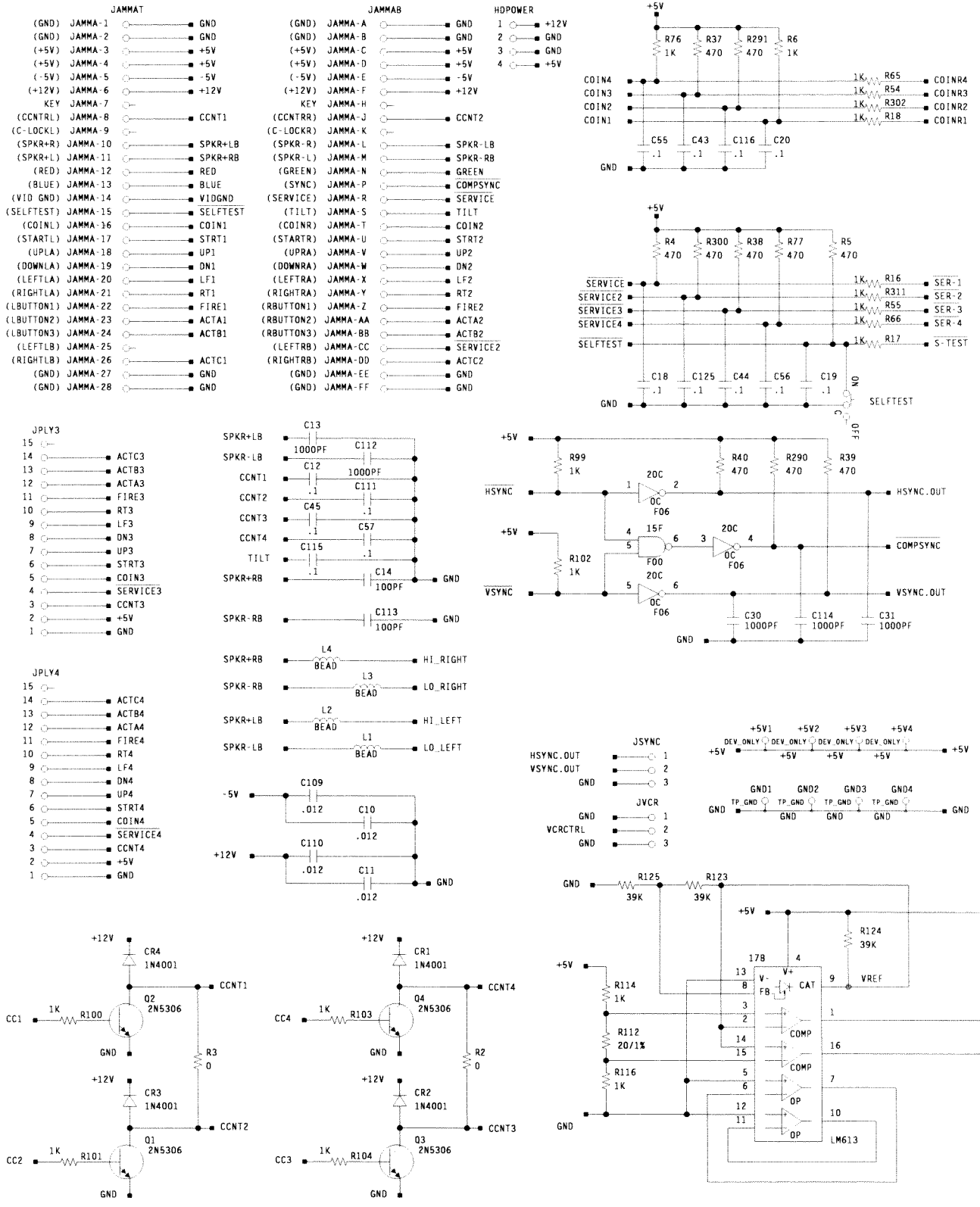
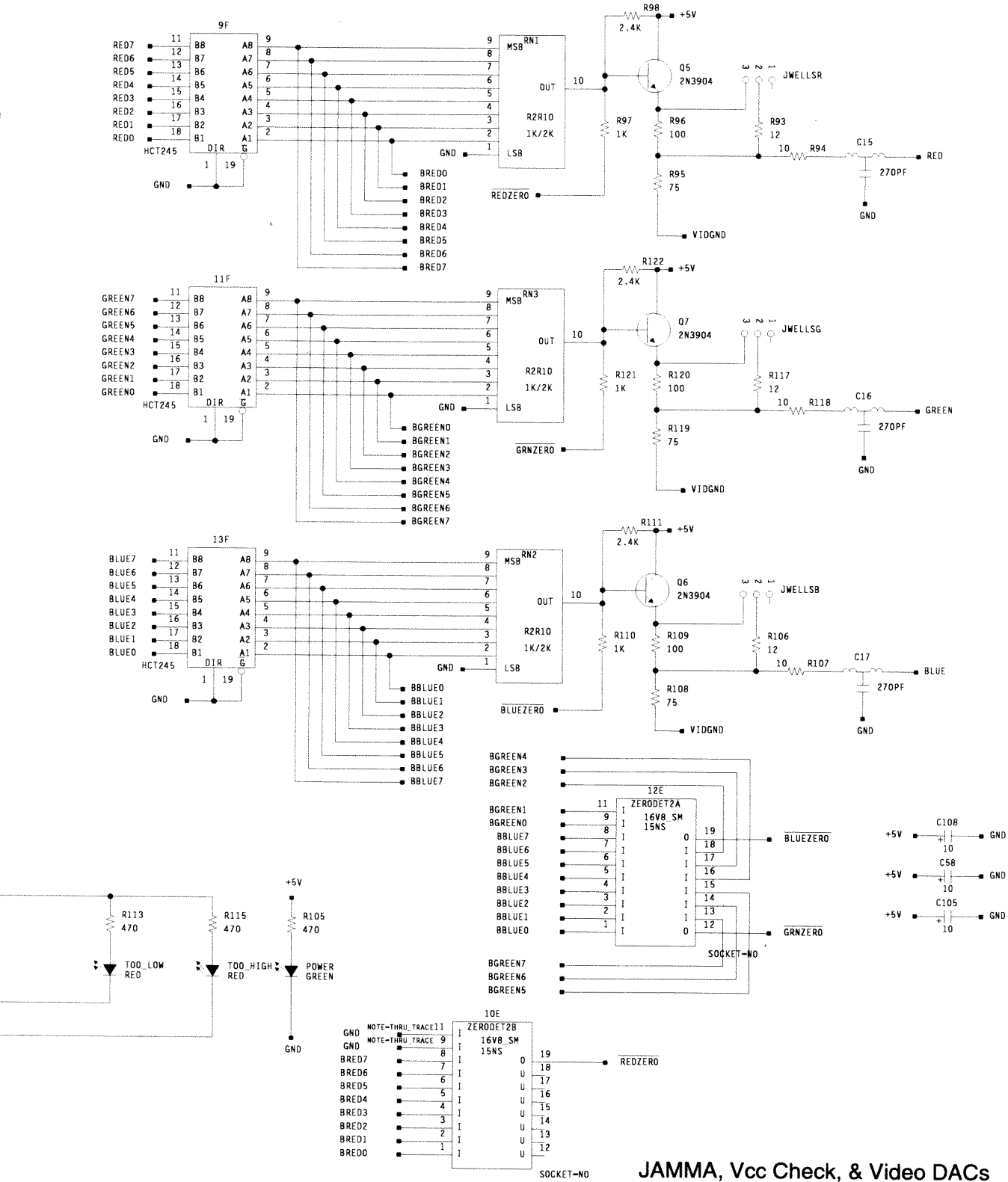

Figure 5-2 Cojag Board Schematic Diagram
Sheet 2 of 10

053537-XX Rev. D



JAMMA, Vcc Check, & Video DACs

Figure 5-2 Cojag Board Schematic Diagram, Continued

Sheet 2 of 10

053537-XX Rev. D

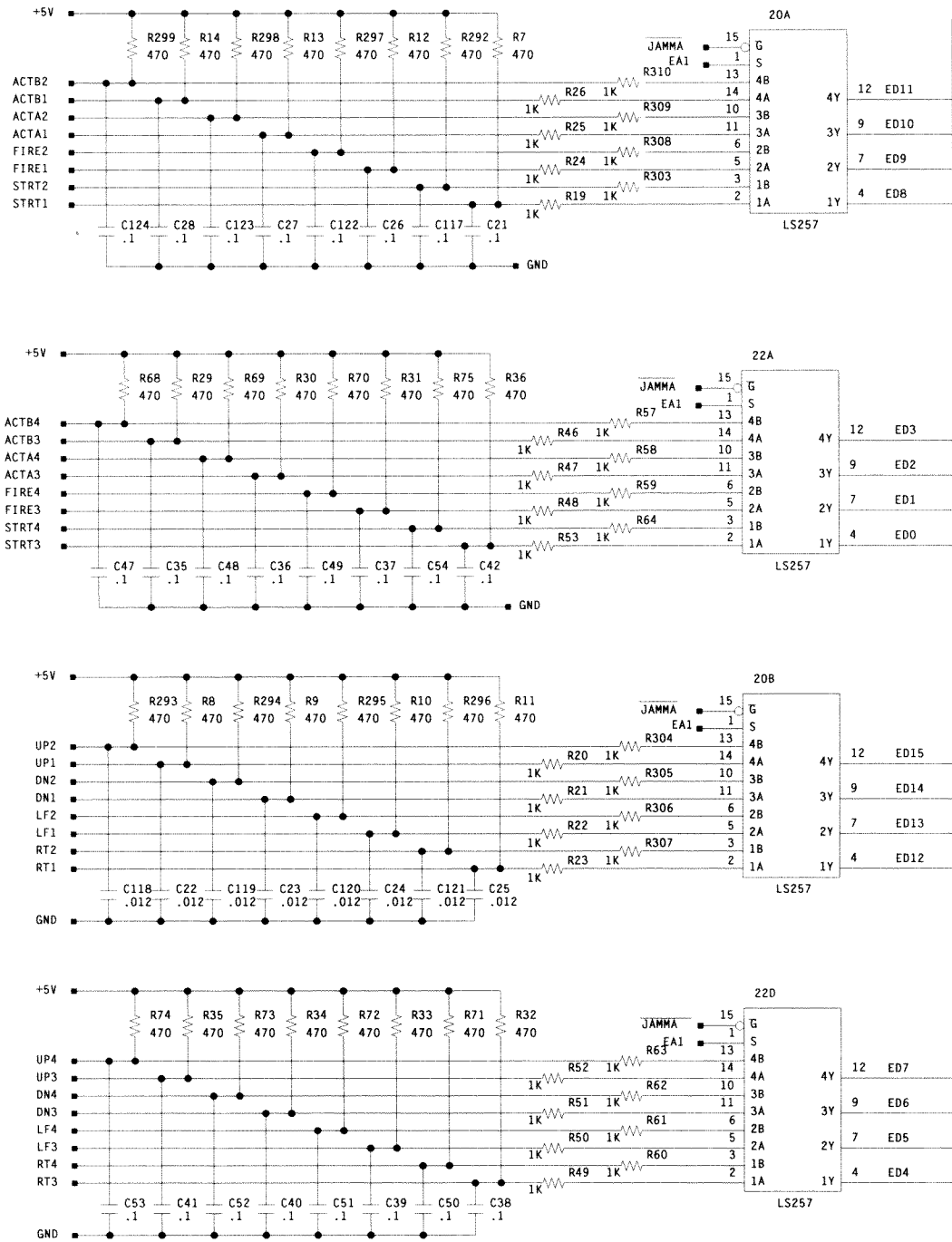

JAMMA Registers & Decode

Figure 5-2 Cojag Board Schematic Diagram, Continued
Sheet 3 of 10

053537-XX Rev. D

ED[15:0]

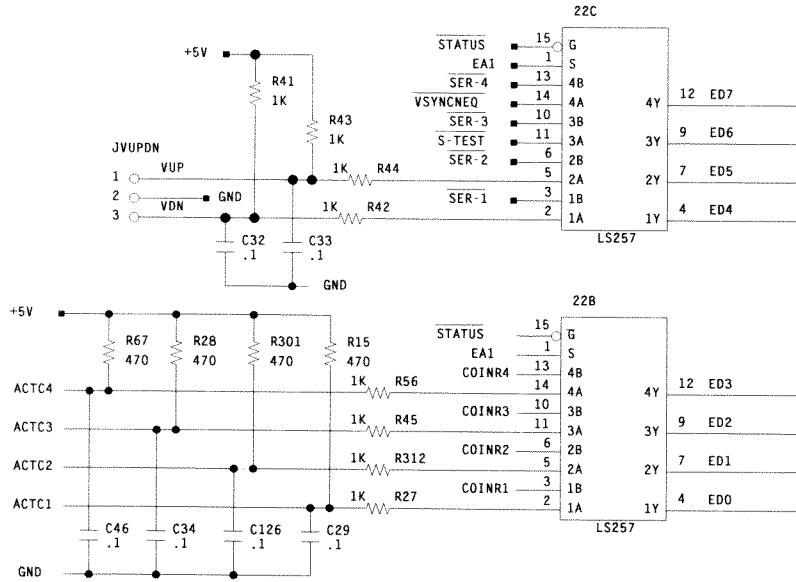

Figure 5-2 Cojag Board Schematic Diagram, Continued
Sheet 3 of 10

053537-XX Rev. D

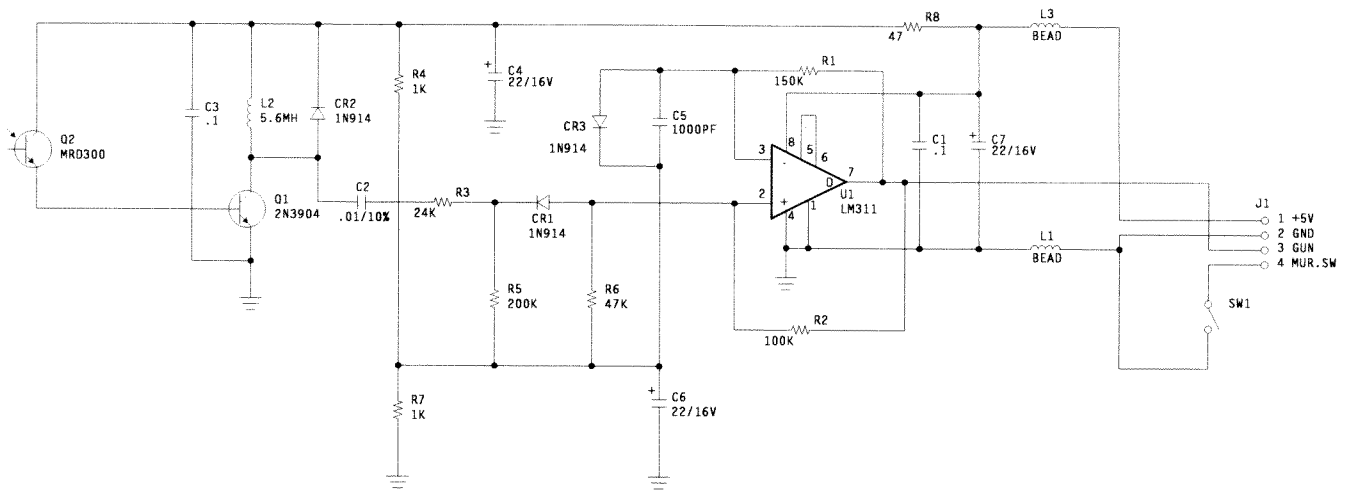

Figure 5-3 Gun Board Schematic Diagram

51987-XX Rev. B

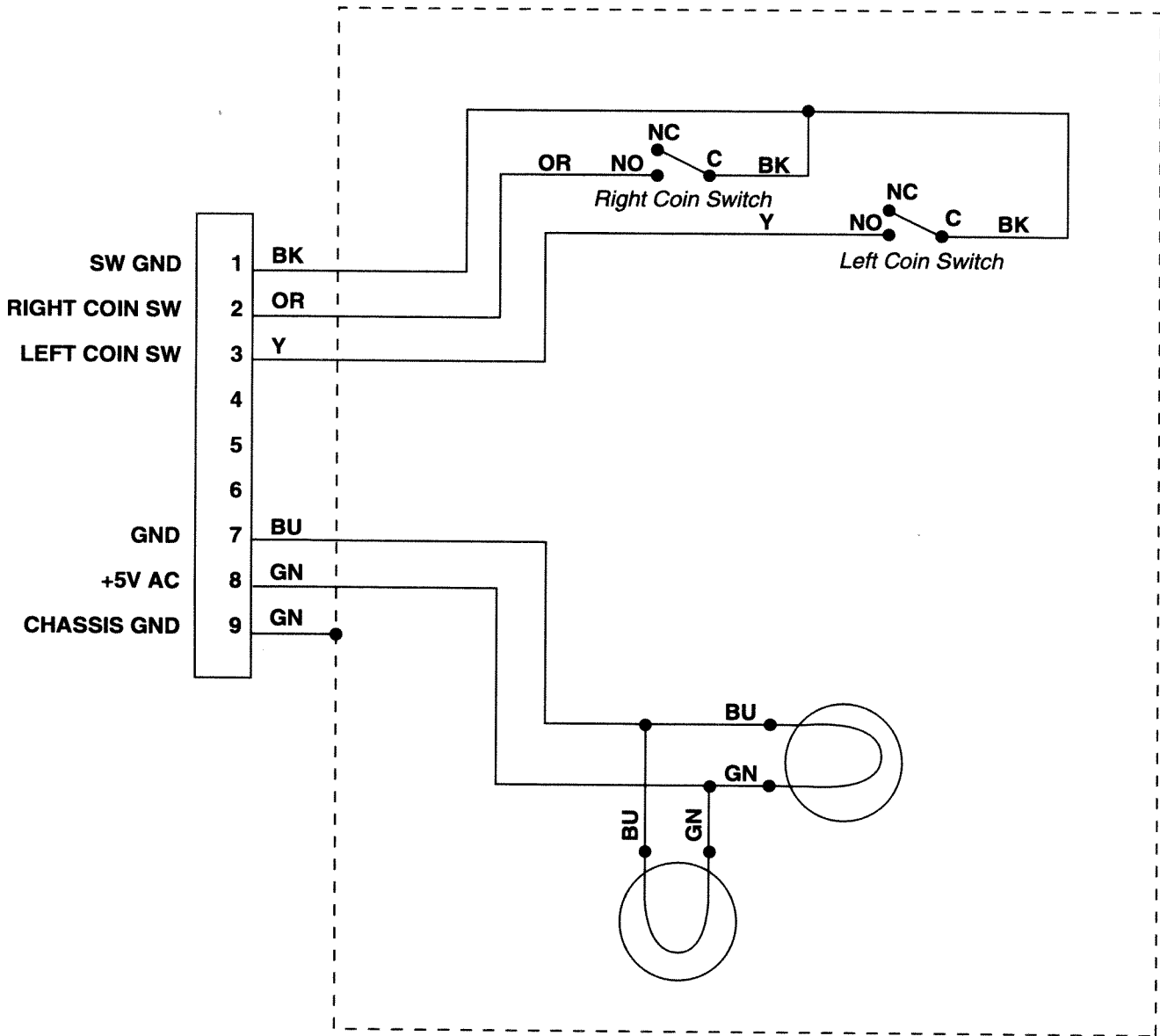

Figure 5-4 Coin Door Wiring Diagram

047366-01 Rev. A

NOTES

Warranty

Seller warrants that its printed-circuit boards and parts thereon are free from defects in material and workmanship under normal use and service for a period of ninety (90) days from date of shipment. Seller warrants that its video displays and laser-video disc players (in games supplied with displays and video-disc players) are free from defects in material and workmanship under normal use and service for a period of thirty (30) days from date of shipment. None of the Seller's other products or parts thereof are warranted.

If the products described in this manual fail to conform to this warranty, Seller's sole liability shall be, at its option, to repair, replace, or credit Buyer's account for such products which are returned to Seller during said warranty period, provided:

- (a) Seller is promptly notified in writing upon discovery by Buyer that said products are defective;
- (b) Such products are returned prepaid to Seller's plant; and
- (c) Seller's examination of said products discloses to Seller's satisfaction that such alleged defects existed and were not caused by accident, misuse, neglect, alteration, improper repair, installation, or improper testing.

In no event shall Seller be liable for loss of profits, loss of use, incidental or consequential damages.

Except for any express warranty set forth in a written contract between Seller and Buyer which contract supersedes the terms herein, this warranty is expressed in lieu of all other warranties expressed or implied, including the implied warranties of merchantability and fitness for a particular purpose, and of all other obligations or liabilities on the Seller's part, and it neither assumes nor authorizes any other person to assume for the Seller any other liabilities in connection with the sale of products by Seller.

The use of any non-Atari parts may void your warranty, according to the terms of the warranty. The use of any non-Atari parts may also adversely affect the safety of your game and cause injury to you and others. Be very cautious in using non-Atari-supplied components with our games, in order to ensure your safety.

Atari distributors are independent, being privately owned and operated. In their judgment they may sell parts or accessories other than Atari parts or accessories. Atari Games Corporation cannot be responsible for the quality, suitability or safety of any non-Atari part or any modification including labor which is performed by such distributor.



S.T.A.A.R. TEAM



TIME WARNER
INTERACTIVE™

675 Sycamore Drive
Milpitas, CA 95035 U.S.A.

(Formerly known as Atari Games Corporation)