

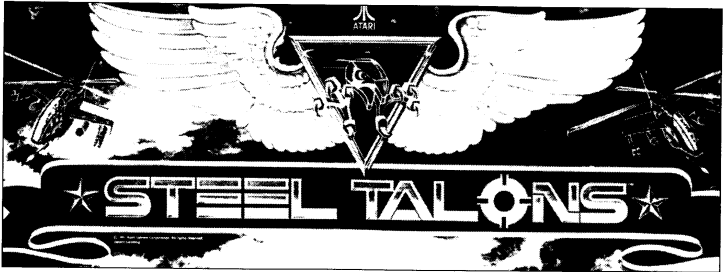


TM-370  
1st printing

The cover art for Steel Talons is a high-contrast, black and white illustration. It depicts a large, dark, angular aircraft in the foreground, with its wings and tail sections prominent. In the background, a smaller, white aircraft is shown in flight against a backdrop of stylized, angular mountains. The overall aesthetic is reminiscent of early computer graphics. The title 'STEEL TALONS' is centered in a bold, blocky font, with a circular reticle symbol integrated into the letter 'O'.

# STEEL TALONS™

**Operator's Manual**



# Operator's Manual

with Parts Illustrations

*Patents are pending on several parts of the Steel Talons game.*

**Copyright © 1988, 1989, 1990, 1991  
by Atari Games Corporation.  
All rights reserved.**

No part of this publication may be reproduced by any mechanical, photographic or electronic process, or in the form of a phonographic recording, nor may it be stored in a retrieval system, transmitted, or otherwise copied for public or private use, without permission from the publisher.

The game play, all graphic designs, this technical manual, its accompanying schematic diagrams, and the display manual are protected by the U.S. Copyright Act of 1976.

This Act provides for substantial penalties for violating federal copyright laws. Courts can impound infringing articles while legal action is pending. If infringers are convicted, courts can order destruction of the infringing articles.

In addition, the Act provides for payment of statutory damages of up to \$50,000 per infringing transaction in certain cases. Infringers may also have to pay costs and attorneys' fees and face an imprisonment of up to five years as well as fines of up to \$250,000 in the case of individuals and up to \$500,000 in the case of corporations.

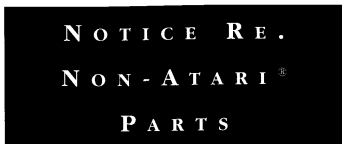
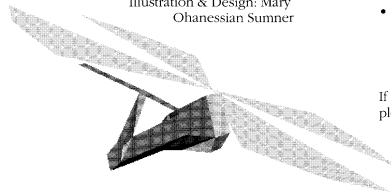
Atari Games Corporation will aggressively enforce its copyrights against infringers. We will use all legal means to immediately halt any manufacture, distribution, or operation of a copy of video games made by us. Anyone who purchases such copies risks forfeiting such a game.

Published by:  
Atari Games Corporation  
675 Sycamore Drive  
P.O. Box 361110  
Milpitas, California 95036

Printed in the U.S.A. **8/91**

Produced by the Atari Games Technical Publications Department.

Writing & Editing: Andrea Dencker  
Illustration & Design: Mary  
Ohanessian Sumner



**WARNING**

*Use of non-Atari parts or modifications of any Atari game circuitry may adversely affect the safety of your game, and may cause injury to you and your players.*

You may void the game warranty (printed on the inside back cover of this manual) if you do any of the following:

- Substitute non-Atari parts in the game.
- Modify or alter any circuits in the game by using kits or parts *not* supplied by Atari Games Corporation.

**NOTE**

This equipment generates, uses, and can radiate radio frequency energy, and if not installed and used in accordance with the instruction manual, may cause interference to radio communications. It has been tested and found to comply with the limits for a Class A computing device pursuant to Subpart J of Part 15 of Federal Communications Commission (FCC) Rules, which are designed to provide reasonable protection against such interference when operated in a commercial environment. Operation of this equipment in a residential area or modification to this equipment is likely to cause interference, in which case the user, at his own expense, will be required to take whatever measures may be required to correct the interference. If you suspect interference from an Atari game at your location, check the following:

- All ground wires in the game are properly connected as shown in the game wiring diagram.
- The power cord is properly plugged into a grounded three-wire outlet.
- On games provided with an Electromagnetic Interference (EMI) ground plane, be sure that the game printed-circuit boards (PCBs) are properly installed on the EMI ground plane and that the end board is securely installed with **all** screws in place and tightened.

If you are still unable to solve the interference problem, please contact Customer Service at Atari Games Corporation. See the inside front cover of this manual for service in your area.

# CONTENTS

## 1 Set-Up

How to Use This Manual.....	1-1
Operating the Game.....	1-2
Inspecting the Game.....	1-2
Assembling the Game.....	1-2
Setting Up the Software.....	1-3
Control and Switch Locations.....	1-3
Setting the Coin and Game Options.....	1-4
Game Systems.....	1-4
Maximizing Earnings.....	1-4
Game Play.....	1-4

## 2 Self-Test

<b>Testing the Game</b> .....	2-1
<b>Entering and Exiting the Self-Test</b> .....	2-2
<b>Automated Self-Test</b> .....	2-3
Program ROM and RAM Test.....	2-3
Microprocessor and Board Tests.....	2-3
<b>Test Menu Screens</b> .....	2-4
<b>Operator Screens</b> .....	2-4
Coin Options.....	2-4
Game Options.....	2-4
Reset Pot Values.....	2-6
Statistics.....	2-6
Histogram 1: Whole Game Times in Minutes.....	2-8
Histogram 2: Time/Credit in Seconds.....	2-9
Histogram 3: Number of Times Level Started.....	2-9
Histogram 4: Number of Times Level Quit at.....	2-9
Histogram 5: Number of Times Bonus Awarded at This Level.....	2-9
Histogram 6: Percentage of Time Played in Real Flight.....	2-9
Error Counts.....	2-9
High Scores.....	2-9
<b>Control Inputs Screen</b> .....	2-9

<b>Monitor Test Patterns</b> .....	2-10
<b>Set Time Screen</b> .....	2-10
<b>Special Functions Screen</b> .....	2-11

## 3 Maintenance and Troubleshooting

<b>Introduction</b> .....	3-1
<b>Maintaining the Coin Mechanism</b> .....	3-3
<b>Repairing the Video Display</b> .....	3-3
Removing the Video Display.....	3-3
Replacing the Video Display.....	3-4
<b>Joystick Control</b> .....	3-4
<b>Foot Pedal Assembly</b> .....	3-4
<b>Collective Control</b> .....	3-4
<b>ROMs and RAMs</b> .....	3-4
<b>LEDs on the Multisync PCB</b> .....	3-6

## 4 Illustrated Parts Lists

Part Ordering Information..... 4-1  
For figure and page numbers, see the List of Illustrations that follows.

## Statistics Sheet

After the end of Chapter 4.

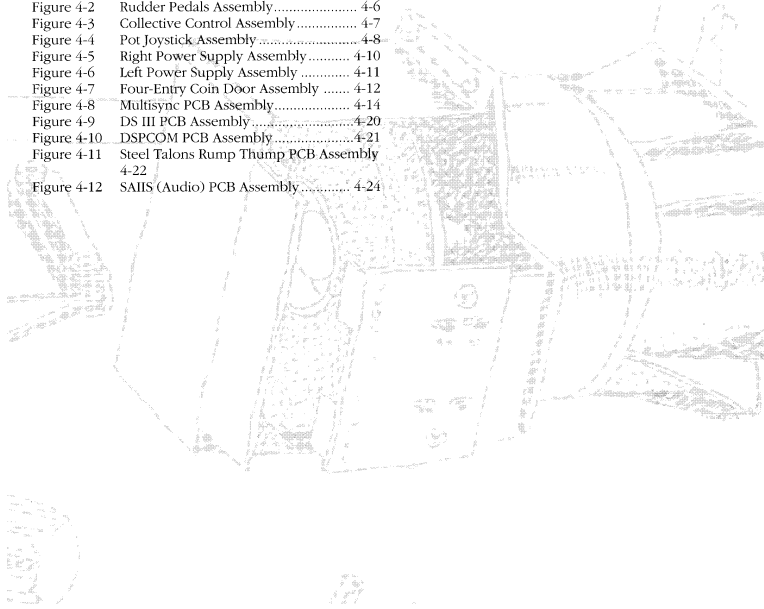
## Glossary

## ILLUSTRATIONS

Figure 1-1	Game Assembly .....	1-3
Figure 2-1	Program ROM and RAM Test Screen ...	2-3
Figure 2-2	Microprocessor and Board Tests Screen...	2-3
Figure 2-3	Test Menu Screen .....	2-4
Figure 2-4	Coin Options Screen .....	2-4
Figure 2-5	Game Options Screen .....	2-5
Figure 2-6	Reset Pot Values Screen .....	2-5
Figure 2-7	Statistics Screen .....	2-8
Figure 2-8	First Histogram Screen .....	2-9
Figure 2-9	Error Counts Screen .....	2-9
Figure 2-10	Control Inputs Screen .....	2-10
Figure 2-11	Set Time Screen.....	2-10
Figure 2-12	Special Functions Screen .....	2-11
Figure 3-1	DIP Switch and LED Locations on the Multisync PCB .....	3-5
Figure 4-1	Cabinet-Mounted Assemblies .....	4-2
Figure 4-2	Rudder Pedals Assembly.....	4-6
Figure 4-3	Collective Control Assembly.....	4-7
Figure 4-4	Pot Joystick Assembly.....	4-8
Figure 4-5	Right Power Supply Assembly.....	4-10
Figure 4-6	Left Power Supply Assembly .....	4-11
Figure 4-7	Four-Entry Coin Door Assembly .....	4-12
Figure 4-8	Multisync PCB Assembly.....	4-14
Figure 4-9	DS III PCB Assembly.....	4-20
Figure 4-10	DSPCOM PCB Assembly.....	4-21
Figure 4-11	Steel Talons Rump Thump PCB Assembly 4-22	
Figure 4-12	SAIS (Audio) PCB Assembly.....	4-24

## TABLES

Table 1-1	Simulator Specifications .....	1-2
Table 2-1	Using the Self-Test Screens and Diagnostics .....	2-2
Table 2-2	Coin Option Settings .....	2-5
Table 2-3	All Screens Appearing in the Self-Test.....	2-6
Table 2-4	Game Option Settings .....	2-8
Table 3-1	Troubleshooting Table .....	3-2
Table 3-2	Voltage Inputs and Test Points on the PCBs .....	3-3
Table 3-3	What ROM Problems Look Like.....	3-4
Table 3-4	Atari Games Video Connector (J10) Pin Assignments.....	3-4
Table 3-5	LED Status.....	3-6



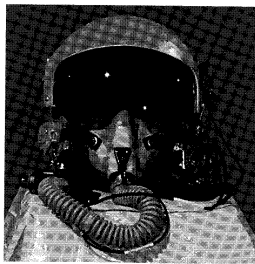
# Set-Up



## HOW TO USE THIS MANUAL

This manual is written for operators and service personnel. It provides information for setting up, playing, testing, and maintaining your Steel Talons™ game. Steel Talons is a one- or two-player helicopter flying game that uses

two sets of controls and monitors to provide a very realistic sensation of the landscape ahead and below the player. ¶ Chapter 1 contains set-up and game play information. ¶ Chapter 2 contains self-test procedures and additional diagnostic tests. The self-test is important in the Steel Talons game. You can troubleshoot the PC boards, main circuits, and controls us-



ing more than 60 screens in the self-test. You should regularly test the boards and controls with the self-test to keep your game in peak condition and at top earnings. ¶ Chapter 3 contains the preventive maintenance schedule for the

game and the repair procedures, flowcharts, and troubleshooting tables for each control. If you have problems with your game, use this chapter to troubleshoot and to repair it. Be sure to perform the preventive maintenance tasks to keep your game in good condition. ¶ Chapter 4 contains the illustrated parts lists.

## Operating the Game

To operate your game for maximum income, make sure your players know that the game is designed to be flown like a real helicopter. You should regularly do the automated self-test and check the controls with the *Control Inputs* screen in the self-test. By using the self-test regularly, you can find and fix problems immediately. This lets you keep your game in top condition.

### NOTE

*If you are installing a new printed-circuit (PC) board or a control in your game, go through the Reset Pot Values screen in the self-test. This is explained in Chapter 2, Self-Test.*

## Inspecting the Game

### WARNING

*To avoid electrical shock, do not plug in the cabinet until it has been properly inspected and set up for the line voltage in your area.*

This cabinet should be connected to a grounded three-wire outlet only. If you have only two-wire outlets, we recommend that you hire a licensed electrician to install grounded outlets. Players can receive an electrical shock if the cabinet is not properly grounded.

Inspect your Steel Talons game carefully to ensure that the game is complete and was delivered to you in good condition.

Inspect the cabinet and seat as follows:

1. Examine the exterior of the cabinet for dents, chips, or broken parts.
2. Open the upper and lower rear access panels. Unlock and open the coin doors. Inspect the interior of the cabinet as follows:
  - a. Check that all plug-in connectors on the cabinet harnesses are firmly plugged in. Do not force connectors together. The connectors are keyed so they fit only in the proper orientation. A reversed connector can damage a printed-circuit board (PCB). This will void your warranty.
  - b. Ensure that all plug-in integrated circuits on each PCB are firmly plugged into their sockets.
  - c. Inspect the power cord for any cuts or dents in the insulation.
  - d. Inspect the power supply. Make sure that the correct fuses are installed. Check that the harness is plugged in correctly and that the fuse

Characteristic	Specification
<b>Power Consumption</b>	480 W maximum
<b>Line Fuse Rating</b>	4 Amps
<b>Line Voltage</b>	102 to 132 VAC
<b>Temperature</b>	5° to 38° C (37° to 100° F)
<b>Humidity</b>	Not to exceed 95% relative
<b>Width</b>	49.5 inches (125.7 cm)
<b>Depth</b>	69 inches (175.3 cm)
<b>Height</b>	73 inches (185.5 cm)
<b>Shipping Weight</b>	974 lbs. (442 kg)
<b>Assembled Weight (approx.)</b>	900 lbs. (409 kg)

**Table 1-1 Simulator Specifications**

block cover is mounted in place. Check that the green ground wires are connected.

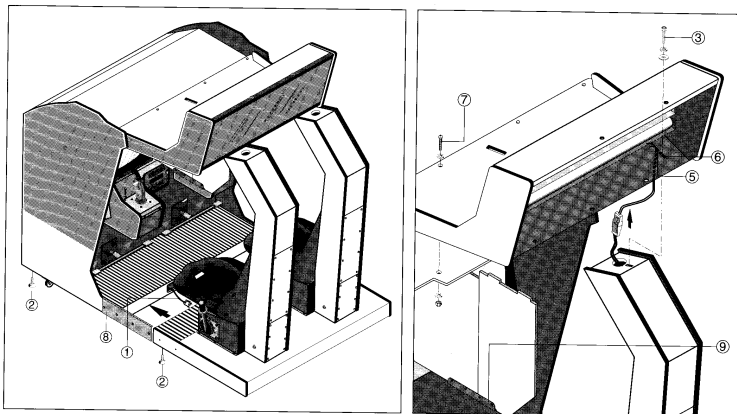
- e. Inspect other sub-assemblies, such as the video display, controls, printed-circuit boards (PCBs), and speakers. Make sure that they are mounted securely and that the ground wires are connected.

## Assembling the Game

The game, seat platform, and attraction assembly are shipped in three separate boxes. You will need a helper to assemble the game. Refer to Figure 1-1 during this procedure.

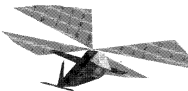
The assembly hardware described below is packaged inside the coin box. Most of the steps below are illustrated with circled numbers in Figure 1-1.

1. Push the seat platform close to the game, so that they are about 6 inches apart. Plug the three game cords and the harness into the corresponding seat platform sockets (the sockets and cords are labeled). Push the excess of the cords into the game cavity, to avoid interference when both structures are joined together.
2. **Make sure the game is in place.** *It is nearly impossible to move the game or readjust the seat platform levelers once the canopy is attached.* Adjust the seat platform levelers so the platform is exactly at the same level as the game cabinet. (Turning the levelers clockwise raises the seat platform.)
3. Unbolt the 1/4-20 hex bolts located at the top of each column. Also remove the lock washer and fender washer.
4. With a helper, push the cabinet against the seat platform. Make sure all the cords remain properly connected.



**Figure 1-1 Game Assembly**

5. Remove the attraction shield from the canopy. Position the canopy on top of the columns. Feed the fluorescent harness from the right column up through the round hole into the attraction box.
6. Align one column's bolt hole with the matching slotted hole on the attraction assembly. The bolt should be located at the center of the attraction assembly. Tighten the bolt, and repeat for the other column. The bolts should be at the center of the slot to ensure clearance for the lower attraction retainer.
7. Push the entire canopy unit towards the game cabinet to align the four bolt holes that secure the canopy and the cabinet. Use 1/4-20 x 2" button-head hex socket bolts, cap-nuts, and washers.
8. To secure the seat platform to the game cabinet, install the black cabinet/platform brackets; use 1/4-20 x 2" button-head hex socket bolts and washers.
9. Install the player divider panel by inserting it into the ceiling slots. Use a rubber mallet to fit the "U" retainer onto the bottom edge of the cabinet divider panel. Use 1/4-20 carriage bolts, washers, and cap-nuts to secure the panel.



## Setting Up the Software

Normally the game arrives fully calibrated and ready to play. However, if you think any of the controls are not operating properly, you should check them in the self-test procedure.

One example of a non-calibrated control is a cyclic indicator in the lower left corner of the screen (a yellow "+" sign) that does not center itself when you release the joystick handle. Another example is any pot control that cannot reach its limits; the joystick and rudder controls have a box in the lower left corner of the screen to test this function during game play. Refer to Chapter 2, *Self-Test*, for more details.

## Control and Switch Locations

### Power On/Off Switch

The power on/off switch is located at the bottom right rear of the cabinet (the *left* when facing the rear of the cabinet).

### Self-Test Switches

The self-test switches (one for each player station) are located behind the coin door on a metal component bracket. Pushing each switch up starts the self-test pro-



cedure. See Chapter 2 for a complete description of the self-test.

The SAIIS (audio) boards also each have a self-test switch. For proper operation of the main self-test switches on the component bracket, make sure the audio board self-test switches are always pushed towards the nearest mounting screw.

### Volume Controls

The volume controls (one for each player station) are digital, but are adjusted with the shafts on the component bracket behind the coin door. Refer to Chapter 2 for information on how to calibrate these potentiometers.

### Coin Counters

The coin counters (one for each player station) are located behind the coin door. The coin counters record the number of coins deposited for the corresponding side of the game.

## Setting the Coin and Game Options

The Steel Talons coin and game options are set in the self-test. Refer to Chapter 2 for the recommended settings and the procedure for setting the options.

## Game Systems

The Steel Talons game uses nine printed-circuit boards to give a realistic look and feel to helicopter flying. These boards and their functions are:

- Two Multisync boards — the main game circuitry. These boards, which are the largest, hold the 68010, the GSP (Graphic Systems Processor), the MSP (Math Systems Processor), and the microprocessor systems. The 68010 system contains program RAM and ROM. The GSP microprocessor system controls the video RAMs (VRAMs). The MSP controls collisions and the helicopter model.
- Two DS III boards — these produce the polygon objects on the screen
- Two DSPCOM (Digital Signal Processor and Communication) boards — these link the two player stations together
- Two SAIIS (Stand-alone Audio II Stereo) boards — these provide the audio for each player station. One channel on each board powers the rear speaker in the column, and produces the helicopter sounds. The other channel powers the

speaker on the control panel and produces all the sound effects, such as missiles firing.

- One Rump Thump/15V Regulator board — this board powers both Rump Thump solenoids (one under each seat). It also provides 15V regulated power to the pots (via the Multisync board).

## Maximizing Earnings

For maximum earnings, regularly maintain your Steel Talons game following the instructions in Table 3-1, in Chapter 3.

When you set up the game and when you collect money, perform the automated self-test and check the controls with the Control Inputs screen in the self-test.

## Game Play

This section describes the features and play of the Steel Talons game.

### Introduction

Steel Talons represents the ultimate in current game technology, offering a realistic helicopter simulation experience to the player. Two players sit side-by-side to play cooperatively on a common mission to seek out and destroy the enemy, or to play a head-to-head game of cat and mouse. Although the cabinet is configured to enhance the appeal of two-player simultaneous play, players can opt to fly solo on the missions and challenge the computer-controlled enemy aircraft and ground targets.

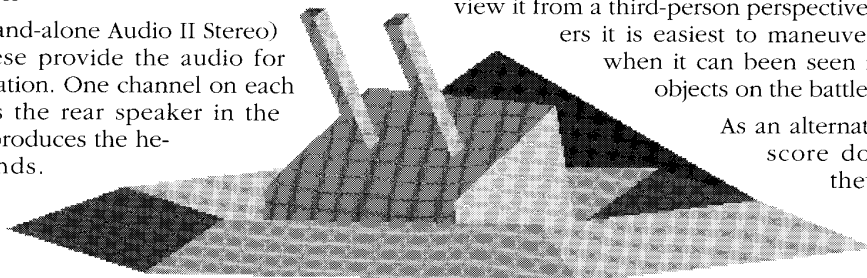
### Details of Game Play

The Steel Talons controls include a cyclic at each player station. This joystick-like device controls movement forward, backward, left and right. Each cyclic has a trigger button to fire the 30 mm machine gun and a thumb button to fire missiles or rockets.

Each player station also has a rudder (a rocking bar at the player's feet), which is used for stationary rotation. A collective (handle at the left side of the player's seat) controls the altitude of the helicopter.

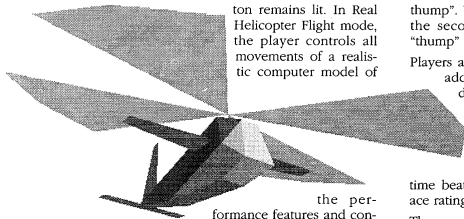
Also included on each control panel is a "zoom" button. This button allows the players to select whether or not they want to zoom out of their helicopter to view it from a third-person perspective. For some players it is easiest to maneuver the helicopter when it can be seen relative to other objects on the battlefield.

As an alternative, players will score double points if they select a first-



person view out the front windscreen of the helicopter.

The control panel also has an optional button for "Real Heli Flight." When pressed, a more realistic helicopter model is enabled and the button remains lit. In Real Helicopter Flight mode, the player controls all movements of a realistic computer model of



the performance features and controls of a modified Blackhawk Model S-67 helicopter. This option is included on Steel Talons to challenge real pilots and skilled players.

Real Helicopter Flight is offered as an experience for skilled players, and as such, it must be specifically selected. If the player crashes during Real Helicopter Flight, the game will default back to the standard computer-assisted flight mode. Players can then switch on Real Helicopter Flight if they desire.

The standard flight mode using computer assist makes controlling a helicopter a breeze even for rookie pilots. The standard flight mode assists players by limiting the speed and altitude so they do not get lost in trying to find the other player and targets to fire upon. The standard flight mode also makes it easier for the players to land their helicopter without crashing. In addition, unrealistically quick acceleration and deceleration is allowed to make the game more fun to play.

Using the mission-select screen, players can choose the type of game they would like to play. For beginning players, there is a training mission that can be used to learn how to fly the Steel Talons simulator. In the training mission, the players follow a flight instructor through an obstacle course, repeating each of the moves made by the helicopter in front of them.

During the combat missions, players can fly solo or play cooperatively to seek out and destroy enemy targets. As the game progresses, the missions become more and more difficult with more and smarter enemy aircraft and ground targets.

Steel Talons also has a head-to-head mission, a favorite for competitive players. The head-to-head mission is a strategic game of hide and seek between the

two player pilots: the objective is to shoot down the other player. The unique design of the Steel Talons cabinet makes it impossible for one player to see the screen of the other player to determine his location.

Steel Talons also features Atari's exclusive "rump thump". When a player gets shot by enemy fire or by the second player, there is an audible and tactile "thump" in his seat from a solenoid.

Players are awarded fuel for completing a mission. In addition, players earn ace, pass, or fail ratings depending upon the time used to complete the mission. At the end of each mission, the player's time is compared to a minimum time needed to pass. For a pass rating, additional fuel is given depending upon how quickly the player completed the level. If his time beats the best time, the player will be given an ace rating and awarded bonus points.

The game is timed by the fuel consumed. The player's fuel level decreases over time and when he is hit by enemy fire. The helicopter can be refueled by depositing more coins to continue the game.

## Game Play Hints

### Head-to-Head Missions

- Stay low to avoid showing up on the other player's map.
- Use the terrain to sneak up on the other player or to set a trap.
- In addition to avoiding the other player, each player may have anti-aircraft batteries or other objects near their starting base. These targets will shoot at the other player. You can also shoot and destroy the other player's targets. There may be radar or other targets in the world which can be destroyed by either player. These targets play a role in determining whether or not you show up on the other player's map.

### Combat Missions

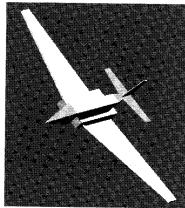
- In a two-player cooperative game, bonus points are awarded to the player with the most kills. 1000 points are awarded for each kill more than the other player.
- Stay low to avoid jets.
- Destroy jets on the runways before they take off.
- Use the map to locate your position and the position of targets.
- Use the radar to locate targets near you.

# Self-Test

## TESTING THE GAME

The Steel Talons™ game is a complex machine. the self-test. Also in the self-test you can check

To keep it at peak efficiency and maximum earnings, you should regularly check the controls, RAMs, ROMs, PCBs, and micro-processor systems. You can check all of these when you switch on



the video display, the statistics, and set the internal clock. If you are having electronic problems, you can check the state of various signals with the LEDs on the Multisync PCB.

You should regularly check the following screens and information. We recommend you check these when you first set up the game, each time you collect money, or when the game is not working correctly:

- Use the automated self-test, which begins automatically when you turn on the self-test to test the program RAMs and ROMs, the video RAMs, color RAMs, the DS III board, the DSPCOM board, and the SAHS sound board. The test takes about 5 minutes to run.
- Check the *Control Inputs* screen, which you choose from the *Test Menu* screen. This shows the voltage input to the Multisync PCB. The *Control Inputs* screen lets you easily check the rump thump solenoid and the Real Heli Flight light. It can also be used if a switch is stuck on or not working.
- Check the *Reset Pot Values* screen to check the range of values for the joystick, foot pedal, collective, and volume control.

### NOTE

*If the pot values or ranges are wrong, your earnings may drop, since the player may not be able to turn, increase speed, or gain altitude.*

- Check the statistics and histograms screens that show the statistical information about how and when your game is played.

Table 2-1 shows you what tests and screens to use at different times and for different problems.

## Entering and Exiting the Self-Test

You enter and exit the automated self-test procedure by turning the self-test switches on or off. The switches are located inside the coin door (a separate switch for each player station). The self-test consists of:

- A five-minute automated self-test of the ROM, RAM, the microprocessor, and the PC boards
- A Test menu from which you can run specific tests in case you receive error messages

### NOTE

*If you are running a specific test and turn off the self-test switch to exit, you may need to proceed through all the screens in the submenu before you return to the attract mode.*

Problem or Type	Explanation
<b>Automated Self-Test</b>	When you switch on the self-test, the automated self-test is performed. This tests the program RAM and ROM and the PCBs. You can skip the self-test by pressing and holding the zoom button as soon as you enter the self-test.
<b>Test Menu</b>	Appears after the automated self-test. Select tests and information on this screen.
<b>Regular Maintenance</b>	Regularly do the following: <ol style="list-style-type: none"> <li>1. Do the automated self-test.</li> <li>2. Check the <i>Operator Screens</i>.</li> <li>3. Go to the <i>Control Inputs</i> screen to test the controls.</li> </ol>
<b>Game Set-Up</b>	When you first set up your game, do the following: <ol style="list-style-type: none"> <li>1. Do the automated self-test.</li> <li>2. Make sure the options on the <i>Operator Screens</i> are set correctly for your location, or set to the defaults. In particular, you should check the pot ranges on the <i>Reset Pot Values</i> screen.</li> <li>3. Go to the <i>Control Inputs</i> screen to test the controls.</li> <li>4. Set the clock, if necessary, using the <i>Set Time</i> screen.</li> </ol>
<b>Control Problem</b>	<ol style="list-style-type: none"> <li>1. Do the <i>Reset Pot Values</i> screen (select the <i>Operator Screens</i> menu item) to recalibrate the controls.</li> <li>2. If that does not correct the problem, go to the <i>Control Inputs</i> screen and see if the input from the control changes as you use the control.</li> <li>3. Go to Chapter 3 and check the troubleshooting table and maintenance information for that control.</li> </ol>
<b>Video Display Problem</b>	Run through the <i>Monitor Test Patterns</i> screens, and compare them with the description later in this chapter.
<b>Electronics Problems</b>	<ol style="list-style-type: none"> <li>1. Do the automated self-test.</li> <li>2. Choose the <i>Special Functions</i> screen that applies to your problems: the GSP (Graphic Systems Processor), program ROM, DS III board, DSPCOM board, or sound board test.</li> </ol>
<b>Game Clock</b>	Use the <i>Set Time</i> screen to set the internal game clock.

Table 2-1 Using the Self-Test Screens and Diagnostics

## Automated Self-Test

When you enter the self-test, the game automatically tests the program ROM and RAM, the video RAM, the color RAM, the MSP (Math Systems Processor) RAM, the DS III PCB, the DSPCOM PCB, and the SAIIS (sound) PCB.

### NOTE

*If you do not see anything on the video display screen, you may have a video display problem or a game system problem. See the DIP Switches section at the end of this chapter to diagnose the problem.*

The automated testing takes about five minutes. The results appear on the screen. Messages in red alert you to a problem. You can run further testing from the Test menu.

If you do not want to wait for the systems and PCBs to be tested, you can skip these tests by pressing the zoom button while in the program ROM and RAM screen, Figure 2-1. (If the self-test proceeds beyond this screen, it will run its course.) If you want to exit to the attract mode, just turn the self-test switch off.

## Program ROM and RAM Test

When you enter self-test, the game tests the program ROM and RAM. The screen in Figure 2-1 shows the results of a program ROM and RAM test.

The top of the screen shows the ROM test result. The numbers on the left and the letters on the top of the

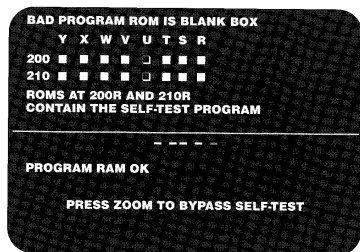


Figure 2-1 Program ROM and RAM Test Screen

screen show the locations of the ROMs on the Multisync PCB. If a white box appears, then the ROM there is good. If an empty box appears (as shown at 200U and 210U), then the ROM there is bad. If nothing appears, then nothing was tested there.

This screen disappears after a few seconds and the self-test continues. However, the screen with the results of the complete self-test, shown in Figure 2-2, shows the message *Bad Program ROM* (or *Bad Program RAM*) if it found an error in the program ROMs or RAMs.

## Microprocessor and Board Tests

After checking the program RAM and ROM, the automated self-test checks the game's microprocessor and PC boards. It tests the video RAM and color RAM in the GSP (Graphic Systems Processor) microprocessor system, the MSP RAM, the DS III board, the DSPCOM board, and the sound board. The test takes four to five minutes. You see the screen in Figure 2-2 when the test is completed.

If the system or board is good, *OK* follows the test name. If it is bad, the word *Bad* precedes the name of the board or system (except for the DS III board test, which gives more information). If you have a bad system or board, then choose *Special Functions* from the Test menu, choose the appropriate system or board tests from the Special Functions menu, and read the description of the tests in this chapter.

Here is a brief description of each microprocessor and board test performed during the automated self-test.

**PROGRAM ROM:** Described above.

**PROGRAM RAM:** Described above.

**GSP VRAM:** Uses the Simple GSP VRAM Test. (De-

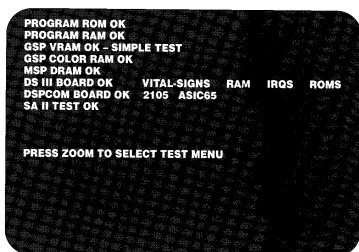


Figure 2-2 Microprocessor and Board Tests Screen

scribed in the section *Multisync Board GSP Tests*.)

**GSP COLOR RAM:** Uses the GSP Color RAM Test. (Described in the section *Multisync Board GSP Tests*.)

**MSP DRAM:** Tests the RAM for the MSP. Most of the error messages are self-explanatory.

**SA II Test:** Tests the SAHS sound board program ROM, RAM, and the sound board communications (SCOM).

## Test Menu Screens

After the microprocessor and board test is finished, a screen of instructions appears on how to use the test menu. After you press the zoom button, the Test menu appears (see Figure 2-3). The Test menu screens let you conduct specific troubleshooting in case of problems. Table 2-3 shows all the tests that are available from the Test menu.

Pressing the trigger or thumb button moves you up or down the menu. When the option you want is white, press the zoom button to select it. The submenus for the specific tests work the same way.

## Operator Screens

Choose *Operator Screens* from the menu by pressing the trigger or thumb button until this item is white, then press the zoom button to select it.

If you are in the operator screens and want to go to the attract mode, first press the zoom button to go through the remaining operator screens. When you return to the Test menu, turn off the self-test switch.

The sequentially-appearing Operator Screens let you set game options and monitor the use of the game. These screens are listed below and are described in the following sections:

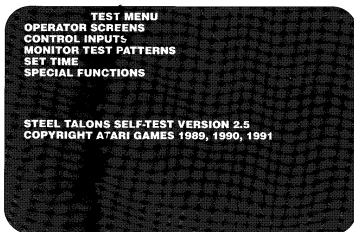


Figure 2-3 Test Menu Screen

- Coin Options
- Game Options
- Reset Pot Values
- Statistics
- Histogram 1: Whole Game Times in Minutes
- Histogram 2: Time Per Credit in Seconds
- Histogram 3: Number of Times Level Started
- Histogram 4: Number of Times Level Quit at This Level
- Histogram 5: Number of Times Bonus Awarded at This Level
- Histogram 6: Percentage of Time Played in Real Flight
- Error Counts
- High Scores

## Coin Options

The first operator screen, Coin Options, lets you change all the options related to game cost (see Figure 2-4). The default setting for each option is green.

Follow the instructions at the bottom of the screen. The available settings are listed and explained in Table 2-2.

## Game Options

Use the Game Options screen to change the operator game options (see Figure 2-5). The default setting for each option is green.

You operate this screen the same as the Coin Options screen. The available settings are listed and explained in Table 2-4.

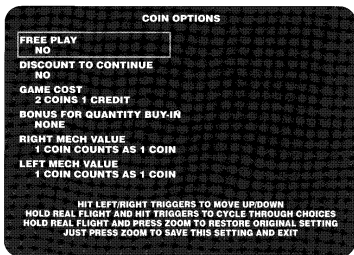


Figure 2-4 Coin Options Screen

Option	Available Settings	Explanation
<b>Free Play</b>	Yes No ✓	Grants free play to players; used mainly for demonstrating the game.
<b>Discount to Continue</b>	Yes No ✓	Lets you offer a reduced price per credit when players want to continue a game (one-half the starting price rounded up).
<b>Game Cost</b>	1 coin 1 credit 2 coins/1 credit ✓ 3 coins/1 credit ... 8 coins/1 credit	Number of coins required for one credit
<b>Bonus for Quantity Buy-in</b>	None ✓ 2 coins give 1 (extra coin) 3 coins give 1 ... 9 coins give 3	Lets you choose from many levels of bonus coins or no bonus.
<b>Right Mech Value</b>	1 coin counts as 1 coin ✓ 1 coin counts as 2 coins 1 coin counts as 3 coins ... 1 coin counts as 8 coins	Number of coins each coin counts as in the right coin mechanism
<b>Left Mech Value</b>	1 coin counts as 1 coin ✓ 1 coin counts as 2 coins 1 coin counts as 3 coins ... 1 coin counts as 8 coins	Number of coins each coin counts as in the left coin mechanism

✓ Manufacturer's recommended settings

Table 2-2 Coin Option Settings

### NOTE

You should always set one side of the game to have Sounds in Attract OFF. This will prevent the attract mode audio from playing at the same time but slightly out of phase.

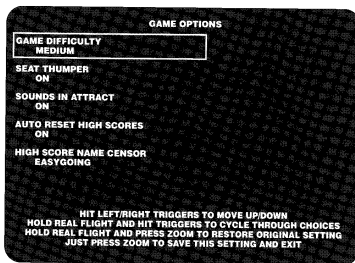


Figure 2-5 Game Options Screen

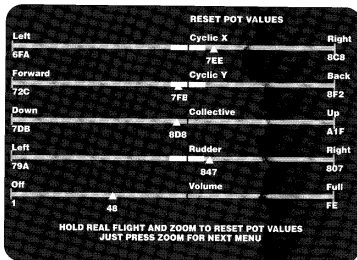


Figure 2-6 Reset Pot Values Screen

Screen	Use
<b>Automated Self-Test</b>	
Program RAM and ROM	Tests the program RAM and ROM.
Automated Self-Test Results	Shows results of the program RAM and ROM, VRAM, color RAM, MSP DRAM, DS III PCB, and sound PCB tests.
<b>Test Menu Screens</b>	
Instructions for Test Menu	Information about using the test menu.
Test Menu	List of available tests and information you can choose.
<b>Operator Screens</b>	
Coin Options	Sets the coin options.
Game Options	Sets the game options and controls the high score table in the attract mode.
Reset Pot Values	Calibrates the game potentiometers.
Statistics	Shows game statistics.
Histograms 1-6	Shows six game histogram screens.
Error Counts	Shows a complete list of the error counts, if any, from the PC boards. Used by the factory for debugging.
High Scores	Shows the top 10 names and scores achieved.
<b>Control Inputs</b>	
	Check this screen <i>regularly</i> to make sure the potentiometers and switches are operating correctly.
<b>Monitor Test Patterns</b>	
	Use these screens to check the performance of your video display.
Color Bars	Shows the video display colors.
Monitor Adjust	Used for the monitor setup.
Monitor Brightness	Shows the brightness adjustment.
Grey Scale	Shows the grey scale of the video display.
BW Dots	Shows convergence and focus of the video display.
BW Grid	Shows convergence and focus of the video display.
Diagonal Lines	Shows linearity of the video display.
Full Screen Grey	Shows the color purity of the video display.
Full Screen White	Shows the color purity of the video display.
Full Screen Red	Shows the color purity of the video display.
Full Screen Green	Shows the color purity of the video display.
Full Screen Blue	Shows the color purity of the video display.
Monitor High Voltage Test	Checks the regulation of the high voltage to the video display.
Scrolling Test	Checks the scrolling mechanism of the GSP microprocessor.
<b>Set Time</b>	
	Set the time so that the display at the bottom of the Test Menu screen reads correctly.

(Continued on next page)

**Table 2-3 All Screens Appearing in the Self-Test**

Reset the pots by simultaneously pressing the Real Heli Flight and Zoom buttons: the lines will change to red. Then move each control to its limits and hold it there for a few seconds. The green hexadecimal number should equal or be very close to the blue number at the end of the line.

- Recalibrate the pots if the range is greater than the pots will reach! Move the controls to their limits to see how far the triangles move to the left and right sides of the screen. If the center green area is red, then the pot does not have enough range. Replace the defective pot or control.
- If the cyclic and rudder cannot return to the center green area, the controls are not correct. For example, in game play you may be flying slightly forward/back or left/right when the cyclic is mechanically centered.

## Statistics

The statistics screen is shown in Figure 2-7. The statistics are collected from the last time the statistics screen was cleared. Write this information on the statistics sheet in the back of this manual to help you maximize your profit.

To move to the next screen, just press the zoom button. To clear the statistics, hold the Real Heli Flight button and press the zoom button at the same time.

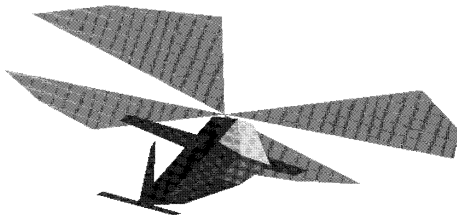
The statistics the game collects are explained below.

- Left Coins* shows the number of coins counted in the left coin mechanism.
- Right Coins* shows the number of coins counted in the right coin mechanism.



Screen	Use
<b>Special Functions</b>	
<b>Main (Multisync) Board GSP Tests</b>	Use this screen for tests of the controls, PCBs, and microprocessors.
VRAM Simple Test	Use this screen if you have a VRAM failure in the automated self-test.
VRAM Verify Test	Checks for bad VRAMs in the GSP microprocessor system.
VRAM Complete Test	Tests all the VRAM GSP memory.
Test VRAM for Display Errors	Completely tests all VRAM.
Color RAM	Completely test all VRAM for incorrect display.
VRAM Shift Register Test	Tests the color RAM.
	Checks the VRAM shift register.
<b>Main (Multisync) Board MSP Tests</b>	In both of the tests below, a color picture appears on the screen when the test is done. This picture represents the MSP circuitry on the Multisync PCB. A green rectangle means the IC is OK, blue means the IC was not tested, and red means the IC is bad.
MSP Verify	Test runs in the MSP chips themselves and tests the MSP. Is very accurate.
MSP Complete Test	Test is run by the 68010 externally.
<b>Main Board ROM Checksums</b>	Use this test if the program ROMs fail the automated self-test.
<b>Main (Multisync) Board ZRAM Test</b>	Check the ZRAM or clear the ZRAM. Use this if all the pots cannot be reset or if the statistics are not kept correctly.
ZRAM Test	Tests the Zero-Power (non-volatile) RAM.
Clear the ZRAM	Clears the Zero-Power (non-volatile) RAM of all data.
<b>DS III Board Tests</b>	
DS III Graphics Program and Data RAM Tested by 68010.	Use this test if the DS III board fails the automated self-test.
2101 Vital Signs	Tests if the 2101 IC is working and able to run a program.
DS III Graphics Program and Data RAM Tested by 2101.	The 2101 runs a standard, complete test on its own program memory.
IRQ Test	Tests if the DS III system can generate IRQs.
Graphics ROM Checksums 68010.	Tests the graphics ROMs on the DS III PCB.
Graphics Special Functions	Performs hardware diagnosis and oscilloscope test loops for use by a repair technician.
<b>DSPCOM Board Tests</b>	
2105 Tests	Use these tests if the DSPCOM board fails the automated self-test.
ASIC 65 Tests	Tests if the 2105 system is working. Goes to a submenu that tests various functions of the 2105.
DSP Link Tests	Goes to a submenu that tests the ASIC65 system.
	Comprehensive DSP link diagnostic for technicians. Goes to a submenu that tests the communication link between both player stations.
<b>Sound Board Tests</b>	
SA (Sound) Board Self-Test	Use these tests if the SAIS (sound) board fails the automated self-test.
Play Sounds	Tests the sound program RAM, ROM, and SCOM chips.
	Choose and hear selected game sounds.

**Table 2-3 All Screens Appearing in the Self-Test, Continued**



Option	Available Settings			Explanation
<b>Game Difficulty</b>	Very Easy Medium ✓ Very Hard	Easy Medium Hard Nasty	Medium Easy Hard	Establishes the degree of game difficulty.
<b>Seat Thumper</b>	On ✓		Off	Lets you turn the seat thumper on/off.
<b>Sounds in Attract</b>	On ✓		Off	Lets you choose whether or not to play music in the attract mode.
<b>Auto Reset High Scores</b>	On ✓		Off	Automatically resets the high scores to the factory defaults after 2000 games, unless a player has entered his initials within the previous 200 games. Also resets the best times for each level.
<b>High Score Name Censor</b>	Easygoing ✓		Strict	Names entered on the high score table are censored; the program deletes letters in possibly objectionable words.

✓ Manufacturer's recommended settings

**Table 2-4 Game Option Settings**

- *Aux Coins* is not used in this game (Steel Talons has no auxiliary coin switches). The number following the *Aux Coins* message should therefore always read 0.
- *Idle Mins* shows the number of minutes the game has been idle.
- *Active Mins* shows the number of minutes the game has been played.
- *Solo Mins* shows the numbers of minutes the game was played in the one-player mode.
- *Linked Mins* shows the numbers of minutes the game was played in the two-player mode.
- *New Games* shows the number of new games that players started.
- *Continues* shows the number of games that players continued.
- *Error Count* shows the number of errors counted in the erasable memory. If you have more than 0 errors, check the ZRAMs with the self-test. Your game may need service.
- *Total Credits* shows the total number of new and continued games played.
- *Total Coins* shows the total number of coins inserted into both coin inlets for this side of the cabinet.
- *Average Time/Coin* shows the average game play time per coin.
- *Average Time/Credit* shows the average game play time per credit. This data depends on how you set the game cost on the Coin Options menu.

## Histogram 1: Whole Game Times in Minutes

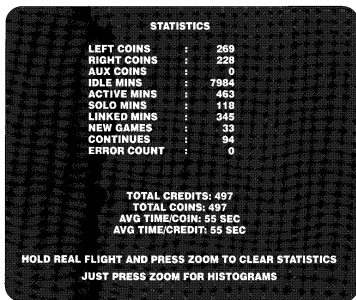
The first histogram screen shows the distribution in the length of playing time in minutes. This screen is shown in Figure 2-8. Write these numbers on the statistics sheet in the back of this manual to help you maximize your profit.

## Histogram 2: Time per Credit in Seconds

This histogram screen shows the distribution of play in length of playing time per credit.

## Histogram 3: Number of Times Level Started

This histogram screen shows how often players started each playing level.



**Figure 2-7 Statistics Screen**

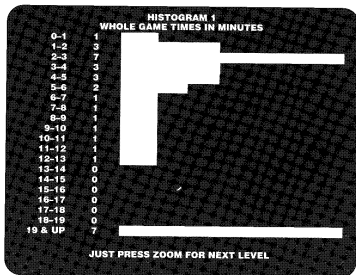


Figure 2-8 First Histogram Screen

## Histogram 4: Number of Times Level Quit at

This histogram screen shows how often players quit at each playing level.

## Histogram 5: Number of Times Bonus Awarded at This Level

This histogram screen shows how often players received bonus points (received an “ace” or “pass” rating) at each playing level.

## Histogram 6: Percentage of Time Played in Real Flight

This histogram screen shows what percentage of the time players pushed the “Real Heli Flight” button and played in the realistic helicopter flying (non-computer-assisted) mode.

To move to the next screen, press the zoom button. To clear all histograms, hold the Real Heli Flight button and press the zoom button at the same time.

## Error Counts

This screen shows a complete listing of the number of errors counted in the erasable memory (see Figure 2-9). If you have many errors listed on the screen, check the ZRAMs with the self-test. Your game may need service.

If you call Atari Games Customer Service, the numbers on the Error Counts screen may help Customer Service personnel troubleshoot your problem. The *Total Errors*

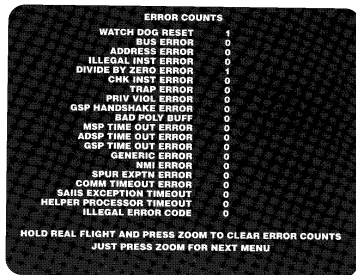


Figure 2-9 Error Counts Screen

on the Statistics screen, by the way, shows Zero-power RAM (ZRAM) errors.

## High Scores

This screen shows the top 10 players’ names as they signed them, plus the scores they achieved.

To clear the high score table, hold the Real Heli Flight button and press the zoom button at the same time.

## Control Inputs Screen

Check this screen as part of your regular maintenance to be sure the potentiometers and switches are operating correctly.

The Control Inputs screen is shown in Figure 2-10. This screen shows the voltage inputs from the control potentiometers to the A/D converter circuits on the Multisync PC board. As you use a control, the line length on the screen changes, showing the change in the voltage input from the potentiometer. If the line length does not change, you have a problem. Check Chapter 3 for troubleshooting and repair information.

The first control on the screen is the volume control (ignore any unlabeled lines in the top half of the screen). The volume control line shows the movement of the volume potentiometer. As you turn the volume control, the line should change.

The middle portion of the screen lets you test the left and right coin switches, the Real Heli Flight switch, the Rump Thump solenoid, and the Real Heli Flight lamp. Activating any of these five controls should make the appropriate words on the screen turn green.

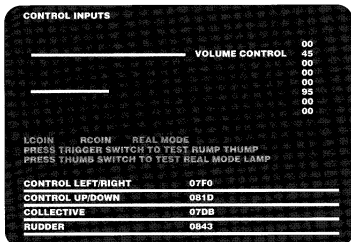


Figure 2-10 Control Inputs Screen

The bottom portion of the screen lets you test the joystick, collective, and rudder foot pedal. (The joystick movement is checked with two lines.) As you use the controls, the lines should become longer and shorter. If the line does not move, then see Chapter 3 for more information.

If the volume control line or any of the bottom four lines are extremely jittery, either that pot is bad or the pot mounted in the control is loose.

For these controls, 0 Volts input appears as no line or a short line on the screen and 15 Volts appears as many lines across the screen.

## Monitor Test Patterns

Use this item to see the fourteen screens for checking the video display, the color RAMs, the GSP, which controls the video RAMs (VRAMs), and the video output. To cycle forwards through the screens, press the thumb button, and to go backwards press the trigger switch.

- *Color Bars* screen shows these colors from left to right: white, yellow, light blue, green, purple, red, blue, and grey. If the colors are incorrect, see your video display manual for adjustment procedures.
- *Monitor Adjust* is used to set up the monitor.
- *Monitor Brightness* checks the adjustment of the video display brightness.
- *Grey Scale* shows a white line on the left, and a grey scale with black on the left.
- *B/W Dots* can be used to check convergence and focus.
- *B/W Grid* shows a black background and a white grid pattern to check convergence. The grid lines should be straight within 3.0 mm. If you need to ad-

just the convergence, see the video display manual included with the game.

- *Diagonal Lines* can be used to check video display linearity.
- *Full Screen Colors* (five screens) test the color purity of the color RAMs and the display. The test displays a grey, white, red, green, and then blue screen. Each screen should be a rectangle of color with no curving at the corners and no lines in the raster. If it does not, see your video display manual included with the game for adjustment procedures.
- *Monitor High Voltage Test* switches between a white screen and a grey screen. If the high voltage to the display is regulated properly, the sides of the screen will fluctuate about  $\frac{1}{8}$  inch from the white to the grey screen.
- *Scrolling Test* checks the scrolling mechanism in the GSP.

## Set Time Screen

Choose this item if you want to set the clock, turn the clock on, or turn it off (see Figure 2-11). *The clock is not used for any functions in this game*, but the day, date, and time are displayed at the bottom of the Test Menu screen.

To be able to change any clock settings, you must first turn on the clock. Choose *Start Clock* from the menu. In about two seconds, the clock starts.

Choose the item you need from the menu by using either the thumb button or trigger switch. Change the setting by pressing the zoom button until you see the correct time, date, or day displayed at the bottom of the screen.

If the clock is losing or gaining time, then use *Clock Faster* or *Clock Slower* to adjust the calibration of the clock.

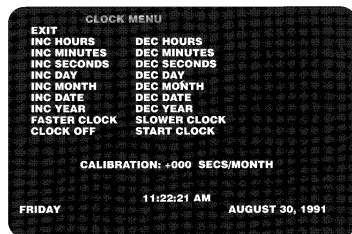


Figure 2-11 Set Time Screen

Turn off the clock only if you plan to store the game more than six months. (The clock has a lithium battery that should last more than five years in normal use.) To turn off the clock, choose *Clock Off* from the clock submenu; then select *EXIT* and press the zoom button. The items on the clock menu are explained below.

- *Exit* returns you to the Test menu.
- *Inc Hours* increments (advances) the hour setting.
- *Inc Minutes* advances the minute setting.
- *Inc Seconds* advances the second setting.
- *Inc Day* advances the day of the week (for example, Monday or Tuesday) setting.
- *Inc Month* advances the month setting.
- *Inc Date* advances the date setting.
- *Inc Year* advances the year setting.
- *Faster Clock* advances the calibration setting. Each increase in this setting makes the clock run about 5 seconds faster per month.
- *Clock Off* turns the clock off.
- *Dec Hours* decrements (reverses) the hour setting, etc.
- *Start Clock* starts the clock.

## Special Functions Screens

Use the items on this screen, shown in Figure 2-12, if a system or board failed the program RAM and ROM test or the board and microprocessor test in the automated self-test. Also use this screen if you have problems with the joystick, collective, or foot pedal, or if the clock settings or the statistics are erratic. The *Special Functions* items are explained as follows:

- *Exit* returns you to the Test menu.
- Main (Multisync) Board GSP Tests should be used if you get the message *Bad GSP VRAM* or *Bad GSP Color RAM* in the automated self-test. This screen has six tests.
- Main Board MSP Tests should be used if you get an MSP error message in the automated self-test. This screen tests the Math Systems Processor.
- Main Board ROM Checksums should be used if you get the message *Bad Program ROM* in the automated self-test. This tests the

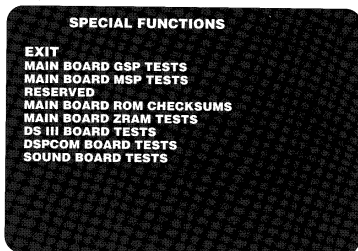
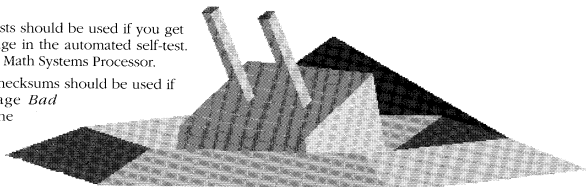


Figure 2-12 Special Functions Screen

program ROMs individually and shows the results on the screen.

- Main Board ZRAM Tests should be used if your controls settings are changing or erratic. Also use these tests if you suspect the game is not keeping the statistics or pot ranges correctly. (See *Error Counts* on the Statistics Screen.)
- DS III Board Tests should be used if you get any message other than *DS III Board OK* for the DS III board test in the automated self-test. This screen has three tests and a DS III ROM checksum test. It also has eight “scope loop” tests for factory use only, since they require schematics and an oscilloscope.
- DSPCOM Board Tests should be used if you get any message other than *DSPCOM Board OK* for the DSPCOM board test in the automated self-test. This screen has three tests.
- Sound Board Tests should be used if you get the message *Bad Sound Board* in the automated self-test.

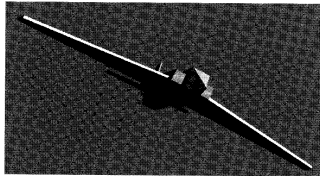


# Troubleshooting and Maintenance

## INTRODUCTION

This chapter contains troubleshooting tables and repair procedures for your Steel Talons™ game. The chapter includes several troubleshooting tables. The tables contain general troubleshooting information, the voltage levels and test points on the game printed-circuit board, a list of ROM-caused problems with specific ROMs to

check and replace, and a description of steering motor problems. The chapter also includes information about connecting the video display if it requires separate positive sync and repair information for the steering control and foot pedal assembly, and locations of the RAMs and ROMs on the game PCB.



<b>Problem</b>	<b>Suggested Action</b>
<b>Coin Mechanism Problem</b>	<ol style="list-style-type: none"> <li>1. Check the wiring to the coin mechanism.</li> <li>2. Check the voltage to the + side of the mechanism.</li> <li>3. Test the coin mechanisms with the sound test screen in the self-test.</li> </ol>
<b>Game Play Problem</b>	<ol style="list-style-type: none"> <li>1. Check the harness and connectors.</li> <li>2. Perform the self-test.</li> <li>3. Check the voltage levels on the PCB. See Table 3-2, <i>Voltage Inputs and Test Points</i>.</li> <li>4. Check <i>What ROM Problems Look Like</i>, Table 3-3, for specific ROM problems.</li> </ol>
<b>Joystick, Collective, or Foot Pedal Problem</b>	<ol style="list-style-type: none"> <li>1. Have the controls been lubricated with the correct type of lubricant? If not, lubricate them as shown in Figure 4-2, 4-3, and 4-4.</li> <li>2. Check the harnesses and connectors.</li> <li>3. Check the switches on the control.</li> <li>4. If you took the control apart, have you reassembled it correctly?</li> <li>5. Make sure all the parts on the control are in good repair. Repair or replace parts.</li> <li>6. Reset the limits on the joystick, collective, and foot pedal controls.</li> </ol>
<b>Sound Problem</b>	<ol style="list-style-type: none"> <li>1. Is the speaker volume turned up? (Volume is adjusted on the bracket inside the coin door.)</li> <li>2. Check the voltage on the Multisync PCB edge connector.</li> <li>3. Check the wiring from the PCB to the speaker.</li> <li>4. Check the voltage level to the PCB. See Table 3-2, <i>Voltage Inputs and Test Points</i>.</li> <li>5. Replace the speaker.</li> </ol>
<b>Video Display Problem</b> Screen is dark.	<ol style="list-style-type: none"> <li>1. Is the game plugged in?</li> <li>2. Is the game turned on?</li> <li>3. Are the connections good?</li> <li>4. Is the line fuse good?</li> <li>5. Is the display brightness turned up?</li> <li>6. Are the solder connections on the line filter and transformer good?</li> <li>7. Is the Multisync PCB edge connector tightly connected?</li> <li>8. Check all of the items below. If you answer <i>no</i> to any question, you have a problem with the video display, not with the game circuitry. See your video display service manual.             <ol style="list-style-type: none"> <li>a. Do you have power to the video display?</li> <li>b. Are the video display's filaments lit?</li> <li>c. Do you have high voltage to the video display?</li> </ol> </li> <li>9. Are the voltage levels to the video display PCB correct? (Power voltage is 100 VAC or 110 VAC, depending on the type of video display. Video signal voltage is 0.5 to 3.5 Volts.)</li> <li>10. If the level is not correct, check the connectors and the harness.</li> </ol> <p>You probably have a serious RAM problem.</p>
Only a colored screen appears.	<ol style="list-style-type: none"> <li>1. Do you have correct power voltage to the video display PCB?</li> <li>2. Do you have correct high voltage to the video display?</li> </ol>
Display area wavers or is too small.	<ol style="list-style-type: none"> <li>1. Is the monitor ground connected to the monitor?</li> <li>2. Are the sync inputs connected properly?</li> </ol>
Picture is wavy.	When you serviced the display, you connected the wires incorrectly. Switch the horizontal or vertical yoke wires on the display.
Picture is upside down.	Use the screens in the self-test to adjust the video display. Use the adjustment procedures in your video display manual.
Convergence, purity or color problems.	Use the centering procedures in your video display manual.
Picture is not centered.	
<b>Seat Thumper Problem</b>	<b>Only qualified technicians having experience with high-power devices should troubleshoot this system. The solenoids and the solenoid/motor PCB run on live voltage and can cause serious injury.</b> For further information, contact your Atari field service representative at (408) 434-3950.
<b>Player Stations Won't Communicate</b>	Make sure the communication link cable between the DSPCOM boards is plugged in.

**Table 3-1 Troubleshooting Table**

Voltage	Test Point or LED	Source and Purpose
+5 ± 0.25 VDC	+5V1	Logic power from the switching power supply.
+5V1	CR6 (Multisync PCB)	Lights when +5V1 is coming from the switching power supply.
	CR3 LED (Multisync PCB)	Lights when 5 V is applied to the PCB and the reset (RST) jumper is open.
+14V	CR11 LED (SAIIS PCB)	Lights when the +14 V supply is good.
+14V	CR10 LED (SAIIS PCB)	Lights when the -14 V supply is good.
+12V	+VOP (pin 4 of LM324)	+12 V from the switching power supply. Positive supply for the analog circuitry.
-5V	-VOP (pin 11 of LM324)	-5V from the switching power supply (if connected). Negative supply for the analog circuitry.
+5V	CR4 LED (SAIIS PCB)	Lights when +5V is present on SAIIS board.

**Table 3-2 Voltage Inputs and Test Points on the PCBs**

## Maintaining the Coin Mechanism

The coin mechanism should be cleaned every three months. For detailed parts information on the coin door, see Figure 4-3. To maintain the coin mechanism:

1. Turn power off to the game. Open the upper coin door.
2. Open the gate on the door covering the magnet. Use the blade of a screwdriver to scrape away any metal filings collected on the magnet.
3. For a thorough cleaning, wash the coin mechanism in hot soapy water. Use a toothbrush to remove any stubborn build-up of residue in the coin path.
4. Dry the coin mechanism with compressed air.
5. If you do not want to use water, brush the loose dust off with a soft brush and scrub the residue in the coin path with a toothbrush. Blow out all the loose dust and dirt with compressed air.

### NOTE

*Never lubricate the coin mechanism with oil or grease.*

## Repairing the Video Display

The Steel Talons game cabinet is designed to accommodate 25-inch horizontal-mounting displays.

### Removing the Video Display

If you have a problem with the video display, first run the self-test procedure to narrow down the cause. To make adjustments to the video display, unlock the service door on the rear of the cabinet.

If you want to repair the video display, remove it from the game by following this procedure:

1. Turn the game power off and wait two minutes. Unplug the power cord for safety.
2. While you wait, unlock the upper rear service door on the cabinet.
3. Remove the two screws that attach the display shield retainer. Using the top finger hole, tilt the top of the shield towards you, and then lift it out of the bottom retainer.
4. Remove the three wood cleats that secure the cardboard bezel. Then remove the bezel in front of the display.

### WARNING High Voltage

*The video display contains lethal high voltages. To avoid injury, do not service this display until you observe all precautions necessary for working on high-voltage equipment.*

### X-Radiation

*This video display is designed to minimize X-radiation. However, to avoid possible exposure to soft X-radiation, never modify the high-voltage circuitry.*

### Implosion Hazard

*The cathode-ray tube (CRT) may implode if struck or dropped. The shattered glass from the tube may cause injury up to six feet away. Use care when handling the display and when removing it from the game cabinet. Also, wear gloves to protect your hands from the sheet-metal edges.*

5. Discharge the high voltage from the cathode-ray tube (CRT). The display assembly contains a circuit for discharging the high voltage to ground when power is



Problem	ROM Causing the Problem	Check the ROM at:
Program works, but non-polygonal (bitmap) objects are missing or bad	Graphics	High: 200V, 200W, 200 X, 200Y (Multisync board) Low: 210V, 210W, 210X, 210Y (Multisync board)
Bad polygonal objects	Graphics	2LM, 2T (DS III board)
Garbage on screen; program doesn't work	Processor Self-test ROM	190K (Multisync board) High: 200R, Low: 210R (Multisync board)
Game program is erratic	Program ROM 1, 2, 3, 4	200S, 210S, 200T, 210T (Multisync board)
No sound or erratic sound	Audio ROM: Audio Program Audio Sound ROMs	1F (SAIIS board) 1M, 1N, 1P, 1R (SAIIS board)
Communication error (two players cannot be linked)	DSP	5F (DSPCOM board)

**Table 3-3 What ROM Problems Look Like**

charging the high voltage to ground when power is removed. However, to make certain, always discharge the display as follows:

- a. Attach one end of a solid 18-gauge wire to a well-insulated screwdriver or wooden handle.
  - b. Attach the other end of the wire to an earth ground.
  - c. Quickly touch the blade end of the screwdriver to the CRT anode by sliding it under the anode cap.
  - d. Wait two minutes and repeat part c.
6. Remove the four bolts and washers that secure the video display. This hardware is at the four corners of the display frame.
  7. Disconnect the harness connectors from the video display.
  8. Pull the video display assembly out through the front of the cabinet. Be extremely careful.

**Replacing the Video Display**

Perform the following procedure to replace the video display in the cabinet.

1. Carefully lift the video display into the cabinet.
2. Install the four sets of bolts and washers that hold the video display assembly.
3. Connect the power and signal harnesses to the video display.  
If you replace the CRT and yoke together, adjust the brightness, size, and centering as described in the video display service manual. Check the purity and convergence according to that manual, but adjust both only if required.
4. Install the video display cardboard bezel, cleats, shield, and retainer.
5. Lock the upper rear service door on the cabinet.

**Joystick Control**

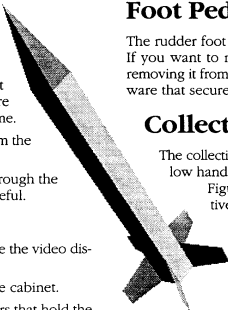
The joystick (cyclic) control is shown in Figure 4-2. If you want to repair the joystick control, disassemble it by removing it from the pod on the control panel. The hardware that secures the pod and joystick control is shown in Figure 4-1.

**Foot Pedal Assembly**

The rudder foot pedal assembly is shown in Figure 4-3. If you want to repair the foot pedal, disassemble it by removing it from the front of the game cabinet. The hardware that secures the foot pedal is shown in Figure 4-1.

**Collective Control**

The collective control assembly (the lever with a yellow handle mounted next to the seat) is shown in Figure 4-4. If you want to repair the collective, disassemble it by removing it from the seat platform. The hardware that secures the collective is shown in Figure 4-1.



Pin	Signal	Pin	Signal
1	Red	7	GND
2	Blue	8	Key
3	GND	9	Negative composite sync
4	Green	10	Positive V sync
5	GND	11	Positive H sync
6	Red		

**Table 3-4 Atari Games Video Connector (J10) Pin Assignments**

## ROMs and RAMs

If you think you have bad ROMs or RAMs, perform the ROM or RAM test in the self-test. If you have a ROM problem, see Table 3-3. If you see only a colored screen and cannot enter the self-test, see Table 3-4 and make sure all connections are working. For the location of all the ROMs and RAMs on the Multisync PCB, see Figure 4-8.

## LEDs on the Multisync PCB

The LEDs (light-emitting diodes) on the Multisync PCB show you the status of various signals on the Multisync PCB. Using the LEDs, you can check signals from various circuits going to the 68010 processor. The state of the signals is indicated by the LEDs that flash or stay lit.

Figure 3-1 shows the location of the LEDs on the Multisync PCB. Table 2-5 shows the possible status of the LEDs, with an explanation of what they indicate.

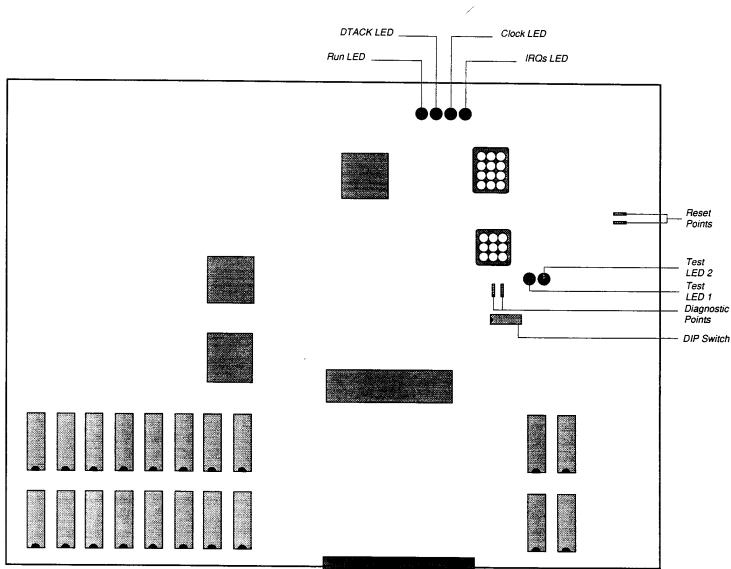


Figure 3-1 DIP Switch and LED Locations on the Multisync PCB

<b>LED</b>	<b>Indicates</b>	<b>Status</b>
<b>Run LED</b>	State of 68010 HALT signal.	On when 68010 is running. Off when 68010 processor is not running. Flashing at 2 Hz if the 68010 cannot run (the watchdog and clock must be running). The Run LED is on in the game mode.
<b>DTACK LED</b>	State of 68010 DTACK (data acknowledge) signal.	On when the 68010 processor is running and the timing circuit is probably operating. Flashes at 2 Hz when the 68010 processor cannot run (the watchdog and processor clock must be running). The DTACK LED is on in the game mode.
<b>Clock LED</b>	State of the 68010 processor clock signal.	On when the game board is on. Off if the processor clock signal is stuck high or low.
<b>IRQS LED</b>	State of all 68010 interrupts.	On in the game mode. Off in hardware diagnostic mode and the early part of self-test. Off if no interrupts are occurring or any interrupt signal is stuck low.

**Table 3-5 LED Status**

# Illustrated Parts Lists

## PART ORDERING INFORMATION

This chapter provides information you need to order parts for your game. ¶

The parts lists (except for the PCB parts lists) are arranged alphanumerically by Atari part number. All A-prefix numbers, which are assemblies, come first. Next are part numbers with six numbers followed by a hyphen (000598- through 201000-). Ending the list are part numbers with a two-number designation followed by a hyphen (00- through 99-). ¶ The PCB parts lists are arranged in alphabetical order by



component. Within each section the parts are arranged numerically by part number. ¶ When you order parts, give the part number, part name, the number of this manual, and the serial number of your game. With this information, we can fill your order rapidly and correctly. We hope this will create less downtime and more profit from your games. ¶ Atari Games Customer Service phone numbers are listed on the inside front cover of this manual.

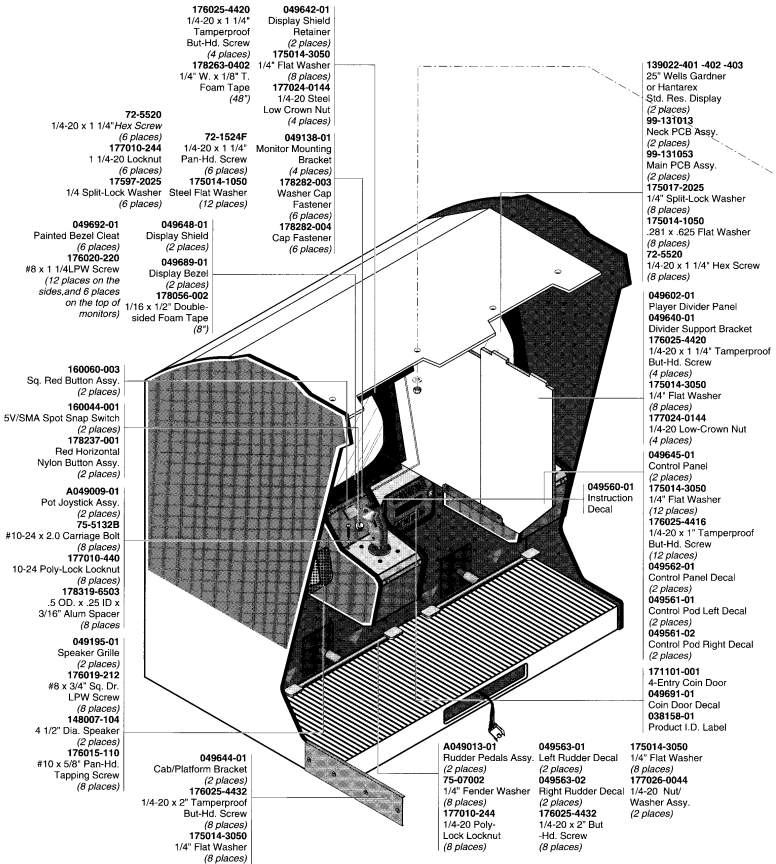


Figure 4-1 Cabinet-Mounted Assemblies, Front View  
A049570-01 D

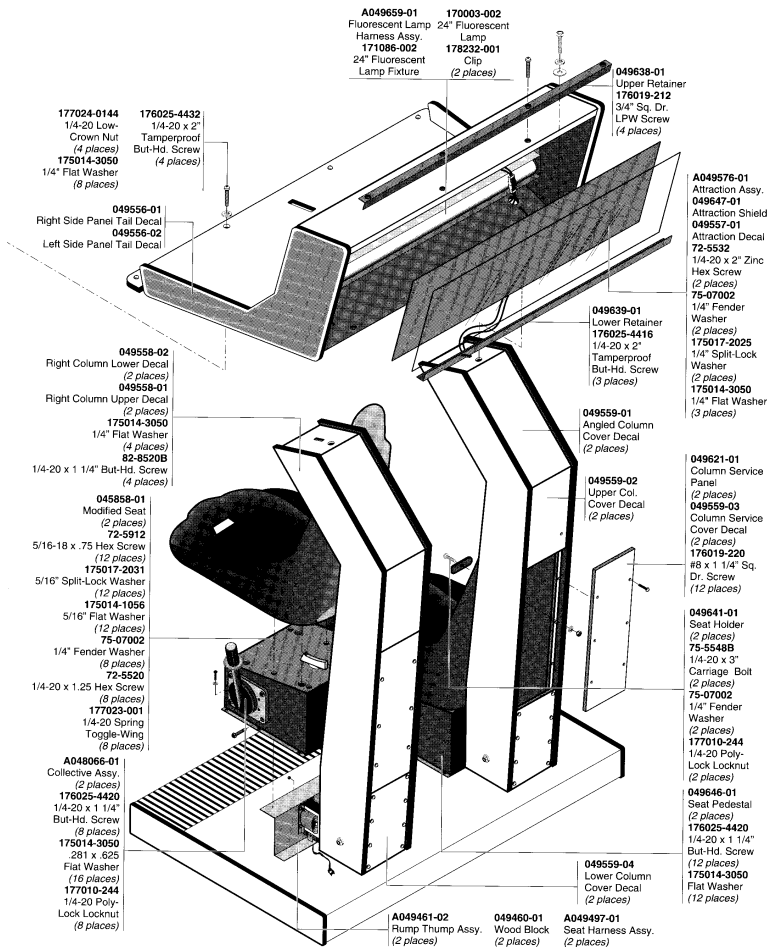
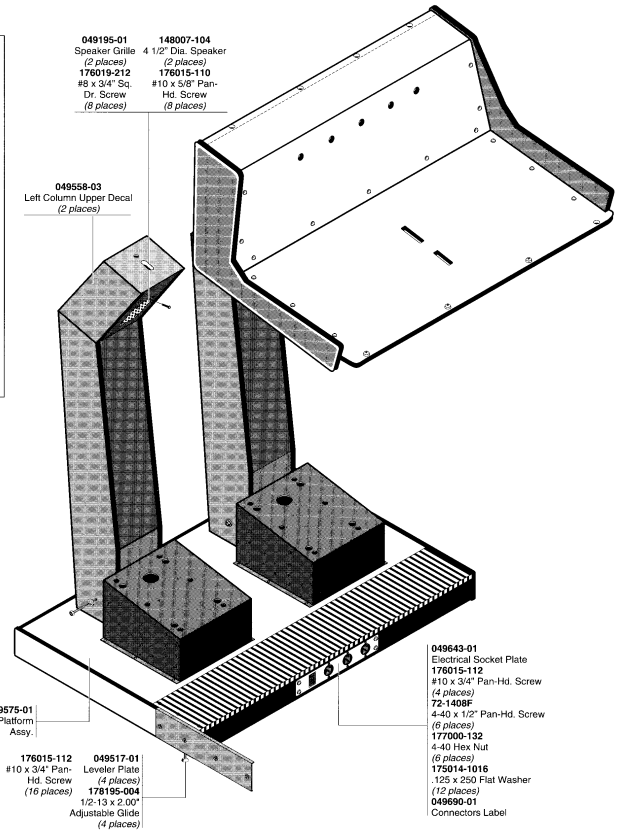


Figure 4-1 Cabinet-Mounted Assemblies, Front View, Continued  
 A049570-01 D

**Items Not Shown:**

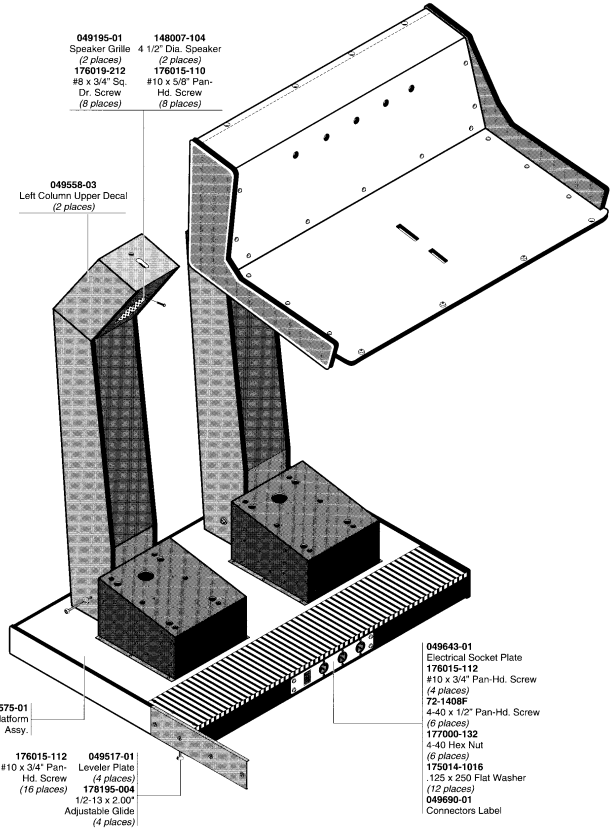
- A049651-01**  
Main Wiring Diagram
- A049652-01**  
Left Main Harness Assy.
- A049653-01**  
Right Main Harness Assy.
- A049657-01**  
Solenoid Harness Assy.
- A049660-01**  
Link Harness Assy.
- A049664-01**  
Display Power Harness Assy.
- A049665-01**  
Left Pwr Supply Wiring Diagram
- A049667-01**  
Right Pwr Supply Wiring Diagram
- TM-330**  
Std. Res. 25" Wells Gardner  
Display Manual  
(also valid for 139022-401  
and 402 displays)
- TM-370**  
Steel Talons Operators Manual
- ST-370**  
Steel Talons Self-Test Label
- SP-370**  
Steel Talons Schematic Package
- 178126-002**  
5/32 Tamperproof  
Hex-key Driver



**Figure 4-1 Cabinet-Mounted Assemblies, Rear View**  
**A049570-01 D**

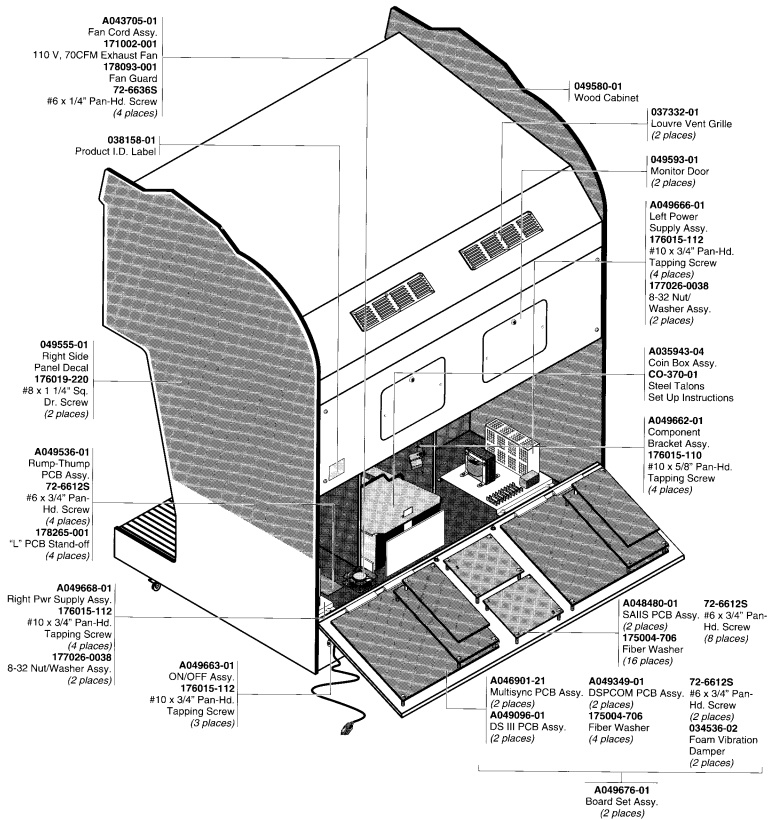
**Items Not Shown:**

- A049651-01**  
Main Wiring Diagram
- A049652-01**  
Left Main Harness Assy.
- A049653-01**  
Right Main Harness Assy.
- A049657-01**  
Solenoid Harness Assy.
- A049660-01**  
Link Harness Assy.
- A049664-01**  
Display Power Harness Assy.
- A049665-01**  
Left Pwr Supply Wiring Diagram
- A049667-01**  
Right Pwr Supply Wiring Diagram
- TM-330**  
Std. Res. 25" Wells Gardner Display Manual  
(also valid for 139022-401 and 402 displays)
- TM-370**  
Steel Talons Operators Manual
- ST-370**  
Steel Talons Self-Test Label
- SP-370**  
Steel Talons Schematic Package
- 178126-002**  
5/32 Tamperproof Hex-key Driver

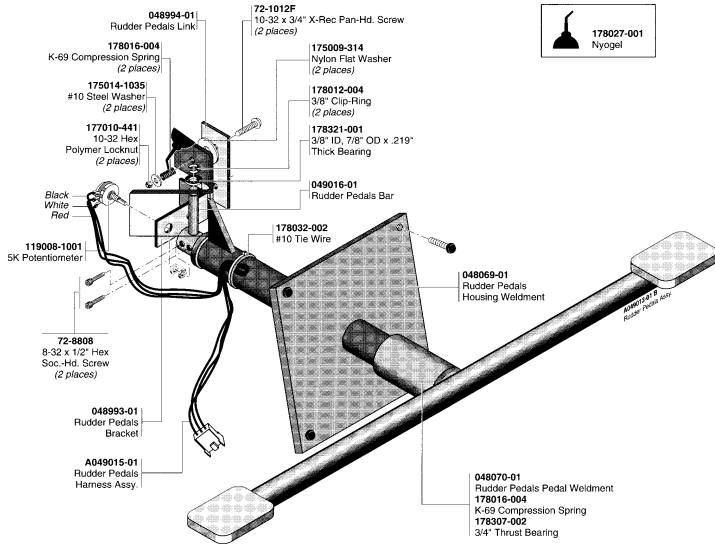


**Figure 4-1 Cabinet-Mounted Assemblies, Rear View**  
**A049570-01 D**

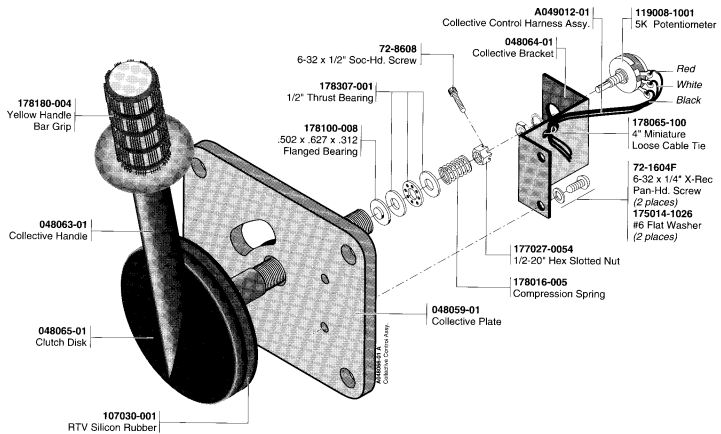




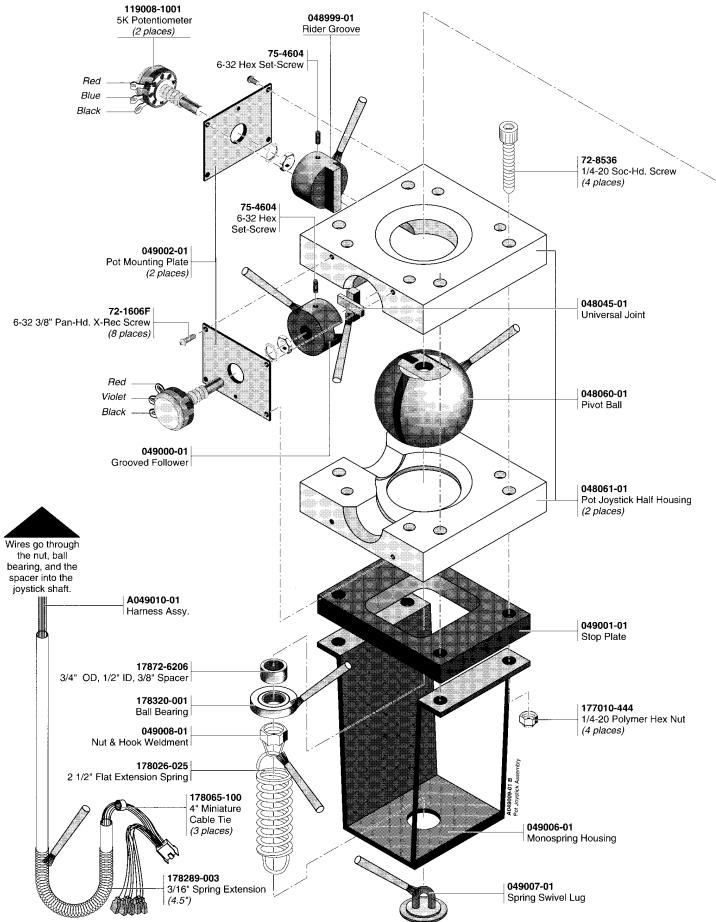
**Figure 4-1 Cabinet-Mounted Assemblies, Rear View, Continued**  
**A049570-01 D**



**Figure 4-2 Rudder Pedals Assembly  
A049013-01 B**

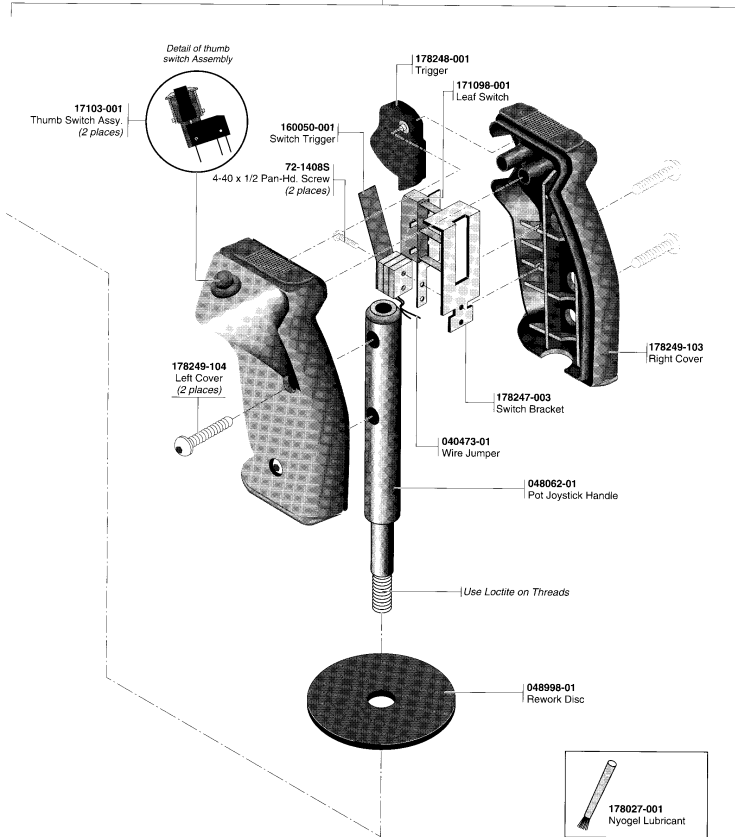


**Figure 4-3 Collective Control Assembly  
A048066-01 A**

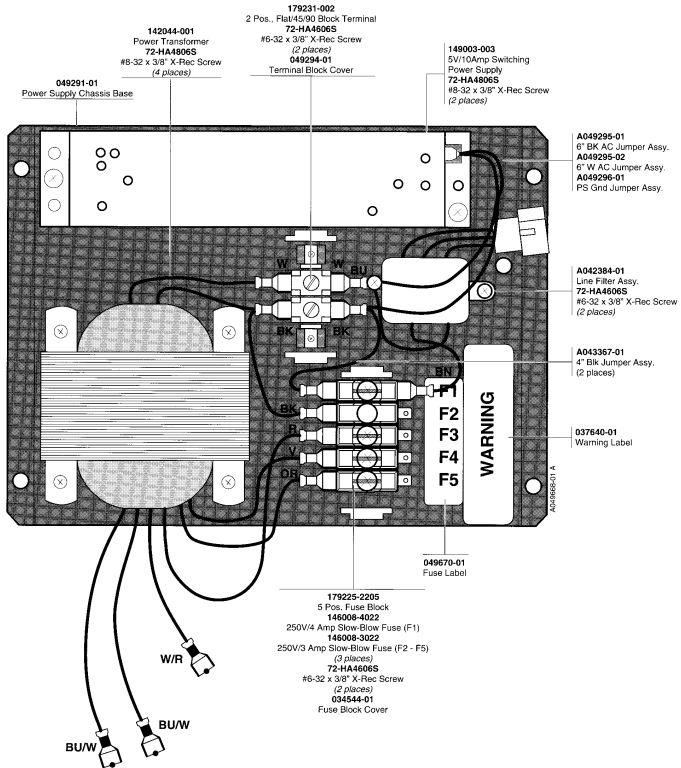


**Figure 4-4 Pot Joystick Assembly  
A049009-01 B**

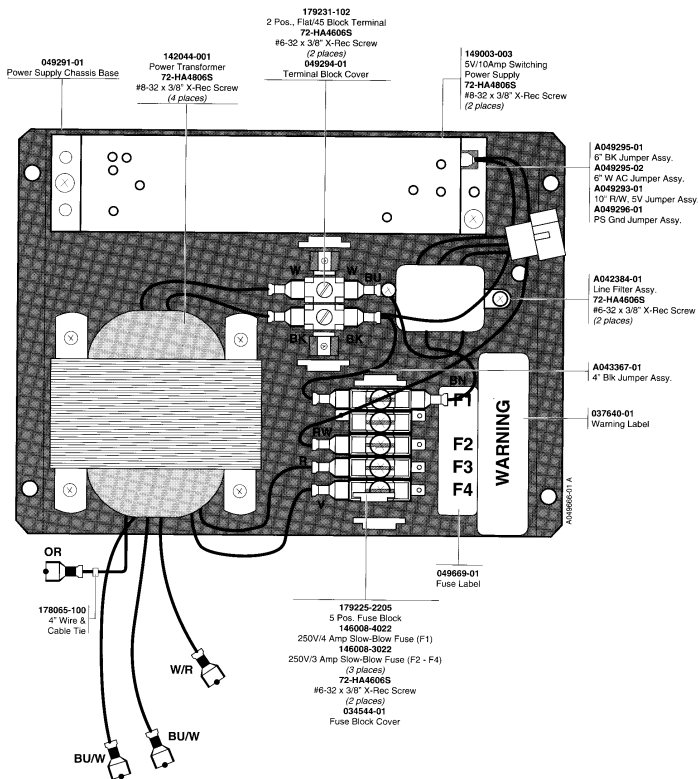
**171100-003**  
 Right Hand Grip Assy.  
 (Includes all parts shown on this page,  
 except the joystick handle and disc)



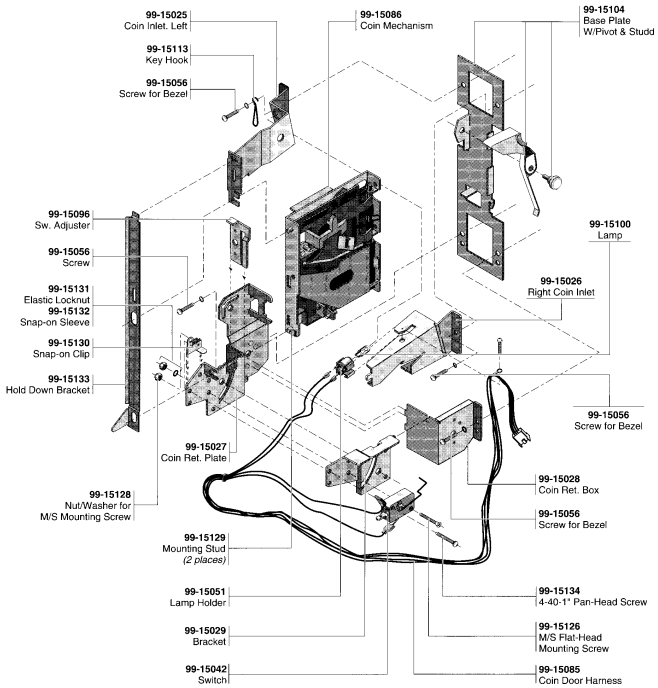
**Figure 4-4 Pot Joystick Assembly, Continued**  
**A049009-01 B**



**Figure 4-5 Right Power Supply Assembly  
A049668-01 A**

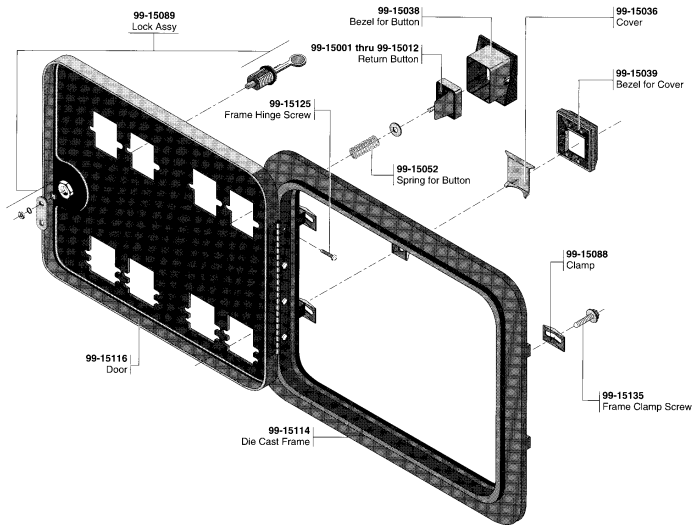


**Figure 4-6 Left Power Supply Assembly  
A049666-01 A**



**Figure 4-7 Four-Entry Coin Door Assembly**  
171101-001





**NOTE:** The Coin Box Assembly was intentionally left out and is shown in the Cabinet-Mounted Assembly drawing on page 4-5 of this manual.

**Figure 4-7 Four-Entry Coin Door Assembly  
171101-001**



NOTE: Production PCBs are stuffed with R198-R203 instead of these 6 capacitors: C5, C6, C7, C8, C10, C14.

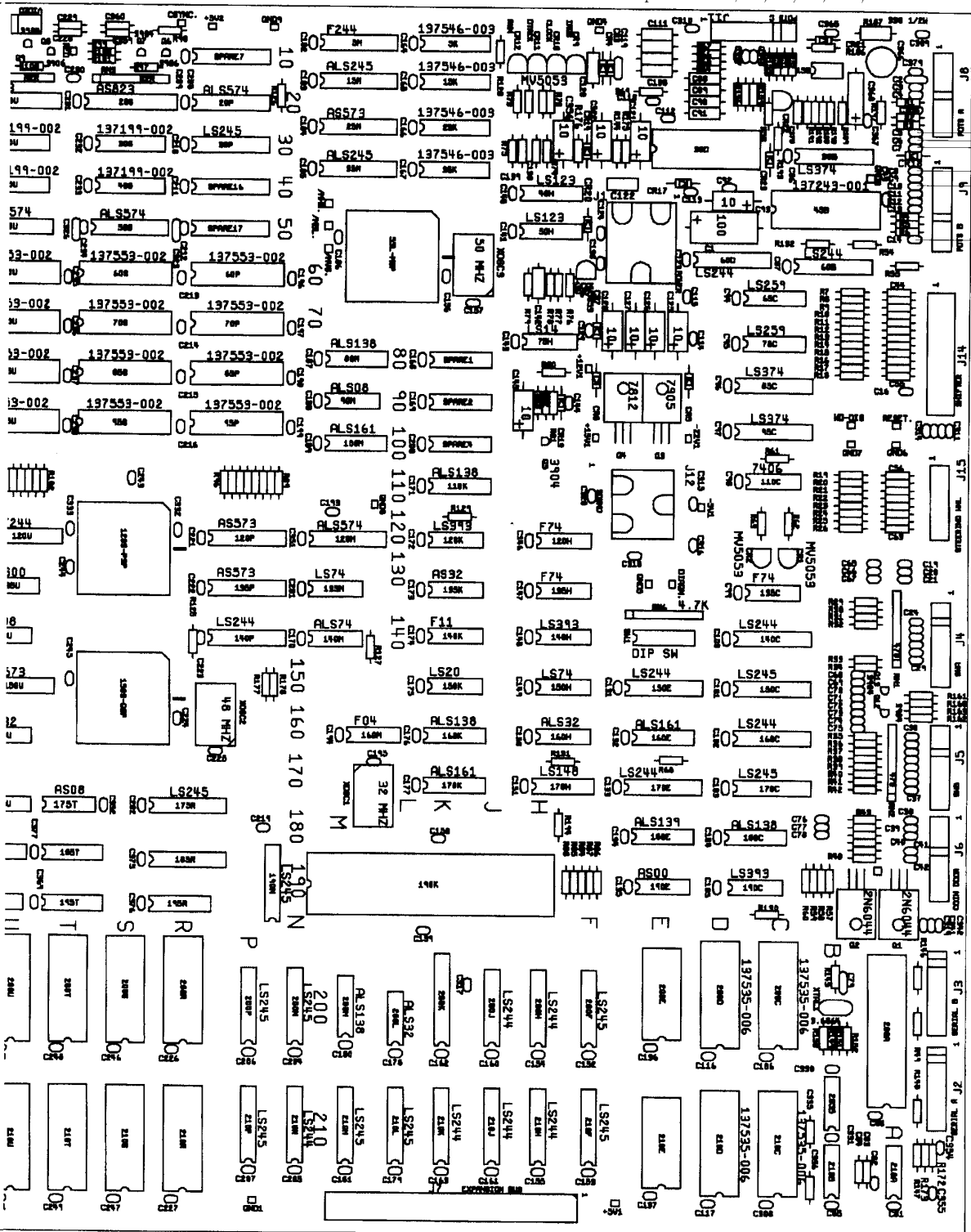


Figure 4-8 Multisync PCB Assembly, Continued  
A044998-03 B

### Multisync PCB Assembly Parts List

Designator	Description	Part No.	Description	Designator	Part No.
30D	Socket, 28 Pin, .600-Inch	179257-028	70Y	Integrated Circuit, 74AS08	137484-001
55L-MSP, 120S-PSP, 150S-GSP	Socket, 68 Pin	179237-068	75C	Integrated Circuit, 74LS259	137137-001
190K	Socket, 64 Pin, .900-Inch	179256-064	75H	Integrated Circuit, 74LS14	137056-001
200E	Socket, 24 Pin, .600-Inch	179257-024	80M	Integrated Circuit, 74ALS138	137517-001
200K	Socket, 24 Pin, .300-Inch	179259-024	85C	Integrated Circuit, 74LS374	137144-001
200R, 200S, 200T, 200U, 200V, 200W, 200X, 200Y	Socket, 28 Pin, .600-Inch	179257-028	85P, 85S, 85U, 85W	Integrated Circuit, VRAM, 64KX4, 150 nsec*	137553-002
210E	Socket, 24 Pin, .600-Inch	179257-024	90M	Integrated Circuit, 74ALS08	137460-001
210R, 210S, 210T, 210U, 210V, 210W, 210X, 210Y	Socket, 28 Pin, .600-Inch	179257-028	95C	Integrated Circuit, 74LS374	137144-001
5K	Integrated Circuit, DRAM, 4464, 64KX4, 150 nsec	137546-003	95P, 95S, 95U, 95W	Integrated Circuit, VRAM, 64KX4, 150 nsec*	137553-002
5M	Integrated Circuit, 74F244	137502-001	100M	Integrated Circuit, 74ALS161	137470-001
15K	Integrated Circuit, DRAM, 4464, 64KX4, 150 nsec	137546-003	110C	Integrated Circuit, 7406	137052-001
15M	Integrated Circuit, 74ALS245	137440-001	110K	Integrated Circuit, 74ALS138	137517-001
20P	Integrated Circuit, 74ALS574	137548-001	120H	Integrated Circuit, 74F74	137436-001
20S,20U,20W	Integrated Circuit, 74BCT29823	137513-003	120K	Integrated Circuit, 74LS393	137146-001
25K	Integrated Circuit, DRAM, 4464, 64KX4, 150 nsec	137546-003	120M	Integrated Circuit, 74ALS574	137548-001
25M	Integrated Circuit, 74AS573	137547-001	120P	Integrated Circuit, 74AS573	137547-001
30B	Integrated Circuit, 74LS374	137144-001	120S-PSP	Integrated Circuit, 34012-50	137559-001
30D	Integrated Circuit, AD7582	137545-001	120U	Integrated Circuit, 74F244	137502-001
30P	Integrated Circuit, 74LS245	137134-001	120W, 120Y	Integrated Circuit, 74AS573	137547-001
30S,30U,30W	Integrated Circuit, 2149, 45 nsec	137199-002	135C, 135H	Integrated Circuit, 74F74	137436-001
30Y	Integrated Circuit, 74LS245	137134-001	135K	Integrated Circuit, 74AS32	137487-001
35K	Integrated Circuit, DRAM, 4464, 64KX4, 150 nsec	137546-003	135M	Integrated Circuit, 74LS74	137023-001
35M	Integrated Circuit, 74ALS245	137440-001	135P	Integrated Circuit, 74AS573	137547-001
40H	Integrated Circuit, 74LS123	137268-001	135U	Integrated Circuit, 74AS00	137480-001
40S,40U,40W	Integrated Circuit, 2149, 45 nsec	137199-002	135W	Integrated Circuit, 74AS573	137547-001
40Y	Integrated Circuit, 74LS245	137134-001	135Y	Integrated Circuit, 74LS259	137137-001
45B	Integrated Circuit, ADC0809	137243-001	140C	Integrated Circuit, 74LS244	137038-001
50H	Integrated Circuit, 74LS123	137268-001	140H	Integrated Circuit, 74LS393	137146-001
50S,50U,50W	Integrated Circuit, 74ALS574	137548-001	140K	Integrated Circuit, 74F11	137583-001
50Y	Integrated Circuit, 74AS573	137547-001	140M	Integrated Circuit, 74ALS74	137156-001
55L-MSP	Integrated Circuit, 34010-50	137538-002	140P	Integrated Circuit, 74LS244	137038-001
60B, 60D	Integrated Circuit, 74LS244	137038-001	140U	Integrated Circuit, 74AS08	137484-001
60P, 60S, 60U, 60W	Integrated Circuit, VRAM, 64KX4, 150 nsec*	137553-002	150C	Integrated Circuit, 74LS245	137134-001
60Y	Integrated Circuit, 74AS138	137522-001	150E	Integrated Circuit, 74LS244	137038-001
65C	Integrated Circuit, 74LS259	137137-001	150H	Integrated Circuit, 74LS74	137023-001
70P, 70S, 70U, 70W	Integrated Circuit, VRAM, 64KX4, 150 nsec*	137553-002	150K	Integrated Circuit, 74LS20	137060-001
			150S-GSP	Integrated Circuit, 34010-50	137538-002
			150U	Integrated Circuit, 74AS573	137547-001
			150W	Integrated Circuit, 74F04	137437-001
			150Y	Integrated Circuit, 74F161	137343-001
			160C	Integrated Circuit, 74LS244	137038-001

### Multisync PCB Assembly, Continued Parts List

Designator	Description	Part No.	Description	Designator	Part No.
160E	Integrated Circuit, 74ALS161	137470-001	210S	Integrated Circuit, EPROM	136087-1003
160H	Integrated Circuit, 74ALS32	137464-001	210T	Integrated Circuit, EPROM	136087-1005
160K	Integrated Circuit, 74ALS138	137517-001	210U	Integrated Circuit, EPROM	136087-1007
			210V	Integrated Circuit, EPROM	136087-1009
160M	Integrated Circuit, 74F04	137437-001			
160U	Integrated Circuit, 74AS32	137487-001	210W	Integrated Circuit, EPROM	136087-1011
160W	Integrated Circuit, 74LS74	137023-001	210X	Integrated Circuit, EPROM	136087-1013
170C	Integrated Circuit, 74LS245	137134-001	210Y	Integrated Circuit, EPROM	136087-1015
			BCLK	Connector, Rcpt, 2 Ckt	179178-002
170E	Integrated Circuit, 74LS244	137038-001		NOTE: Place receptacle for BCLK on "QB".	
170H	Integrated Circuit, 74LS148	137417-001	BCLK.	Connector, 4 Ckt, Header, .100 Ctr	179177-004
170K	Integrated Circuit, 74ALS161	137470-001	BLU.	Test Point	179051-001
175R	Integrated Circuit, 74LS245	137134-001			
			C1	Capacitor, 100 $\mu$ F, 35 V, Electrolytic	124000-107
175T	Integrated Circuit, 74AS08	137484-001	C2	Capacitor, .01 $\mu$ F, 50 V, +80%-20%, Ceramic	122002-103
175W	Integrated Circuit, SCOM	137526-001			
180C	Integrated Circuit, 74ALS138	137517-001	C3-C14, C16,		
180E	Integrated Circuit, 74ALS139	137467-001	C19-C21, C24-C43		
				Capacitor, .1 $\mu$ F, 50 V, $\pm$ 80%- $\pm$ 20%, Ceramic	122002-104
190C	Integrated Circuit, 74LS393	137146-001			
190E	Integrated Circuit, 74AS00	137480-001	C44-C63	Capacitor, 1000 pF, 100 V, Ceramic	122015-102
190K	Integrated Circuit, 68010	137414-002	C65-C78, C80,		
190N	Integrated Circuit, 74LS245	137134-001	C85-C87	Capacitor, .1 $\mu$ F, 50 V, $\pm$ 80%- $\pm$ 20%, Ceramic	122002-104
200C, 200D	Integrated Circuit, RAM, 8KX8, 100 nsec	137535-004	C88-C91	Capacitor, .22 $\mu$ F, 50 V, $\pm$ 10%, Ceramic	122015-224
200E	Integrated Circuit, 48T02-15, RAM	137540-150	C92	Capacitor, .1 $\mu$ F, 50 V, +80%-20%, Ceramic	122002-104
200F	Integrated Circuit, 74LS245	137134-001			
200H, 200J	Integrated Circuit, 74LS244	137038-001			
			C93	Capacitor, 10 $\mu$ F, 35 V, Electrolytic	124000-106
200K	Integrated Circuit, SLOOP	136087-9001	C94-C106	Capacitor, .1 $\mu$ F, 50 V, +80%-20%, Ceramic	122002-104
200L	Integrated Circuit, 74ALS32	137464-001			
200M	Integrated Circuit, 74ALS138	137517-001	C108-C111	Capacitor, .22 $\mu$ F, 50 V, $\pm$ 10%, Ceramic	122015-224
200N, 200P	Integrated Circuit, 74LS245	137134-001	C112-C118	Capacitor, .1 $\mu$ F, 50 V, +80%-20%, Ceramic	122002-104
200R	Integrated Circuit, EPROM	136087-1002			
200S	Integrated Circuit, EPROM	136087-1004			
200T	Integrated Circuit, EPROM	136087-1006			
200U	Integrated Circuit, EPROM	136087-1008			
			C119	Capacitor, 3900 pF, 50 V, Ceramic	122020-392
200V	Integrated Circuit, EPROM	136087-1010	C120	Capacitor, 560 pF, 50 V, Ceramic	122020-561
200W	Integrated Circuit, EPROM	136087-1012	C121	Capacitor, 10 $\mu$ F, 35 V, Electrolytic	124000-106
200X	Integrated Circuit, EPROM	136087-1014	C122	Capacitor, .0022 $\mu$ F, 100 V, Plastic	121022-222
200Y	Integrated Circuit, EPROM	136087-1016			
			C123, C124	Capacitor, .1 $\mu$ F, 50 V, +80%-20%, Ceramic	122002-104
210C, 210D	Integrated Circuit, RAM, 8KX8, 100 nsec	137535-004			
210E	Integrated Circuit, 48Z02-15, RAM	137442-150	C125-C128	Capacitor, 10 $\mu$ F, 35 V, Electrolytic	124000-106
210F	Integrated Circuit, 74LS245	137134-001	C129-C137	Capacitor, .1 $\mu$ F, 50 V, +80%-20%, Ceramic	122002-104
210H, 210J, 210K	Integrated Circuit, 74LS244	137038-001			
			C138, C139	Capacitor, 1000 pF, 100 V, $\pm$ 5%, Ceramic	122016-102
210L, 210M	Integrated Circuit, 74LS245	137134-001	C140, C141	Capacitor, .1 $\mu$ F, 50 V, +80%-20%, Ceramic	122002-104
210N	Integrated Circuit, 74LS244	137038-001			
210P	Integrated Circuit, 74LS245	137134-001	C142	Capacitor, .22 $\mu$ F, 50 V, $\pm$ 10%, Ceramic	122015-224
210R	Integrated Circuit, EPROM	136087-1001	C143, C144	Capacitor, .1 $\mu$ F, 50 V, +80%-20%, Ceramic	122002-104

### Multisync PCB Assembly, Continued Parts List

Designator	Description	Part No.	Description	Designator	Part No.
C145	Capacitor, 10 $\mu$ F, 35 V, Electrolytic	124000-106	CSYNC.	Test Point	179051-001
C146-C189,			DIAGN.	Test Point	179051-001
C193-C202,			GND1-TP9	Test Point	179051-001
C204-C227	Capacitor, .1 $\mu$ F, 50 V, +80%-20%, Ceramic	122002-104	GRN.	Test Point	179051-001
C228	Capacitor, 1000 pF, 100 V, Ceramic	122015-102	J1	Connector, 12 Circuit, Header .250 Ctr	179069-012
C229	Capacitor, 47 pF, 100 V, $\pm$ 5%, Ceramic	122016-470	J4-J6	Connector, 11 Circuit, Header, .100 Ctr	179118-011
C230-C238,			J7	Connector, Header, 60 Circuit, .1 Ctr	179021-060
C243-C249	Capacitor, .1 $\mu$ F, 50 V, +80%-20%, Ceramic	122002-104	J8-J11	Connector, 11 Circuit, Header, .100 Ctr	179118-011
C250	Capacitor, 47 pF, 100 V, $\pm$ 5%, Ceramic	122016-470	J14	Connector, 26 Circuit, Header, .1 X .1 Dual	179261-026
C251-C259,			J15	Connector, 16 Circuit, Header, .1 X .1 Dual	179261-016
C264-C273	Capacitor, .1 $\mu$ F, 50 V, +80%-20%, Ceramic	122002-104	Q1, Q2	Transistor, 2N6044	133042-001
C274	Capacitor, 47 pF, 100 V, $\pm$ 5%, Ceramic	122016-470	Q3	Integrated Circuit, 7905	137581-001
C275-C293,			Q4	Integrated Circuit, 7812	137597-001
C298, C299,			Q5	Transistor, 2N3904	133041-001
C306-C320	Capacitor, .1 $\mu$ F, 50 V, +80%-20%, Ceramic	122002-104	Q6	Transistor, 2N3906	133040-001
C322	Capacitor, 10 $\mu$ F, 35 V, Electrolytic	124000-106	Q7	Transistor, 2N3904	133041-001
C323-C326	Capacitor, 10 pF, 100 V, $\pm$ 5%, Ceramic	122016-100	Q8	Transistor, 2N3906	133040-001
C332, C333,			Q9	Transistor, 2N3904	133041-001
C337-C343	Capacitor, .1 $\mu$ F, 50 V, +80%-20%, Ceramic	122002-104	Q10	Transistor, 2N3906	133040-001
C344-C347	Capacitor, 100 pF, 100 V, $\pm$ 5%, Ceramic	122016-101	Q11-Q13	Transistor, 2N3904	133041-001
C348-C352	Capacitor, .1 $\mu$ F, 50 V, +80%-20%, Ceramic	122002-104	R1-R26	Resistor, 100 $\Omega$ , $\pm$ 5%, 1/4 W	110000-101
C356	Capacitor, 10 $\mu$ F, 35 V, Electrolytic	124000-106	R29-R45	Resistor, 1 K $\Omega$ , $\pm$ 5%, 1/4 W	110000-102
C358	Capacitor, .1 $\mu$ F, 50 V, +80%-20%, Ceramic	122002-104	R46-R48	Resistor, 470 $\Omega$ , $\pm$ 5%, 1/4 W	110000-471
C359, C360	Capacitor, 1000 pF, 100 V, Ceramic	122015-102	R49-R54	Resistor, 4.7 K $\Omega$ , $\pm$ 5%, 1/4 W	110000-472
C369-C377,			R55	Resistor, 100 $\Omega$ , $\pm$ 5%, 1/4 W	110000-101
C379	Capacitor, .1 $\mu$ F, 50 V, +80%-20%, Ceramic	122002-104	R57, R58	Resistor, 1 K $\Omega$ , $\pm$ 5%, 1/4 W	110000-102
CR1, CR2	Diode, MV5053, Light-Emitting	131027-002	R61	Resistor, 4.7 K $\Omega$ , $\pm$ 5%, 1/4 W	110000-472
CR3, CR4	Diode, 1N914	131052-001	R62, R63	Resistor, 220 $\Omega$ , $\pm$ 5%, 1/4 W	110000-221
CR5	Diode, 1N4002	131048-002	R64-R67	Resistor, 5.6 K $\Omega$ , $\pm$ 5%, 1/4 W	110000-562
CR6	Diode, MV5053, Light-Emitting	131027-002	R68	Resistor, 1 K $\Omega$ , $\pm$ 5%, 1/4 W	110000-102
CR7, CR8	Diode, 1N4002	131048-002	R69	Resistor, Metal Film, 56 K $\Omega$ , $\pm$ 1%, 1/4 W	110011-5602
CR9-CR12	Diode, MV5053, Light-Emitting	131027-002	R70-R73	Resistor, 220 $\Omega$ , $\pm$ 5%, 1/4 W	110000-221
CR13	Diode, 1N4002	131048-002	R74, R75	Resistor, 10 K $\Omega$ , $\pm$ 5%, 1/4 W	110000-103
CR14	Diode, MV5053, Light-Emitting	131027-002	R76	Resistor, 220 $\Omega$ , $\pm$ 5%, 1/4 W	110000-221
CR17	Diode, 1N4733 A, 5.1 V, Zener	131009-206	R77, R78	Resistor, 4.7 K $\Omega$ , $\pm$ 5%, 1/4 W	110000-472
CR18	Diode, 1N4002	131048-002	R79	Resistor, 47 K $\Omega$ , $\pm$ 5%, 1/4 W	110000-473
CR19	Diode, 1N4742 A, 12 V, Zener	131009-215	R80, R81	Resistor, 1 K $\Omega$ , $\pm$ 5%, 1/4 W	110000-102
CR20, CR23	Diode, 1N4002	131048-002	R82, R83	Resistor, 470 $\Omega$ , $\pm$ 5%, 1/4 W	110000-471
			R84-R88	Resistor, 10 K $\Omega$ , $\pm$ 5%, 1/4 W	110000-103
			R89-R96	Resistor, 33 $\Omega$ , $\pm$ 5%, 1/4 W	110000-330

### Multisync PCB Assembly, Continued Parts List

Designator	Description	Part No.	Description	Designator	Part No.
R98-R101	Resistor, 100 $\Omega$ , $\pm 5\%$ , 1/4 W	110000-101	SPEED	Connector, 6 Ckt, Header, .100 Ctr	179177-006
R102-R107	Resistor, 33 $\Omega$ , $\pm 5\%$ , 1/4 W	110000-330	SPEED	Connector, Rcpt, 2 Ckt	179178-002
R109-R111,			NOTE: Place receptacle for SPEED on "B".		
R113-R115	Resistor, 100 $\Omega$ , $\pm 5\%$ , 1/4 W	110000-101			
R116-R123	Resistor, 33 $\Omega$ , $\pm 5\%$ , 1/4 W	110000-330	SW1	Switch, 8 Pos DIP	160031-008
R124	Resistor, 220 $\Omega$ , $\pm 5\%$ , 1/4 W	110000-221	TP++1005V1	Test Point	179051-001
R125-R131	Resistor, 1 K $\Omega$ , $\pm 5\%$ , 1/4 W	110000-102	TP++1005V2	Test Point	179051-001
R132	Resistor, 4.7 K $\Omega$ , $\pm 5\%$ , 1/4 W	110000-472	TP++1012V1	Test Point	179051-001
R134	Resistor, 1 K $\Omega$ , $\pm 5\%$ , 1/4 W	110000-102	TP++1015V1	Test Point	179051-001
R144	Resistor, 620 $\Omega$ , $\pm 5\%$ , 1/4 W	110000-621	TP3, TP-TP5V1, TP-TP22V1		
R155	Resistor, 0 $\Omega$ , $\pm 5\%$ , 1/4 W	110005-001		Test Point	179051-001
R156-R159	Resistor, 5.6 K $\Omega$ , $\pm 5\%$ , 1/4 W	110000-562			
R160, R161	Resistor, 10 K $\Omega$ , $\pm 5\%$ , 1/4 W	110000-103	VCLK	Connector, Rcpt, 2 Ckt	179178-002
R162, R163	Resistor, 150 $\Omega$ , $\pm 5\%$ , 1/4 W	110000-151	VCLK	Connector, 6 Ckt, Header, .100 Ctr	179177-006
R164-R167	Resistor, 470 $\Omega$ , $\pm 5\%$ , 1/4 W	110000-471	NOTE: Place receptacle for VCLK on "QB/2".		
R168-R171	Resistor, 10 K $\Omega$ , $\pm 5\%$ , 1/4 W	110000-103	WD-DIS	Test Point	179051-001
R175	Resistor, 91 $\Omega$ , $\pm 5\%$ , 1/4 W	110000-910	XOSC1	Crystal, 32.000, Oscillator Module	144008-002
R176	Resistor, 68 $\Omega$ , $\pm 5\%$ , 1/4 W	110000-680	XOSC2	Crystal, 48 Mhz, Oscillator Module	144008-003
R177, R178	Resistor, 100 $\Omega$ , $\pm 5\%$ , 1/4 W	110000-101	XOSC4	Crystal, 32.000, Oscillator Module	144008-002
R194	Resistor, 10 K $\Omega$ , $\pm 5\%$ , 1/4 W	110000-103	<i>*Acceptable substitute is part no. 137553-001, Integrated Circuit, 64K x 4 VRAM, 120 nsec, or part no. 137553-003, Integrated Circuit, 64K x 4, VRAM, 100 nsec</i>		
RED.	Test Point	179051-001			
RESET.	Test Point	179051-001			
RN1, RN2	Resistor Network, 470X9, $\pm 5\%$ , 1/8 W, SIP (10-pin)	118010-471			
RN3-RN5	Resistor Network, R2R Ladder	118015-001			
RN6	Resistor Network, 4.7KX9, $\pm 5\%$ , 1/8 W, SIP (10-pin)	118010-472			
SCOM	Connector, 11 Circuit, Header, .100 Ctr	179118-011			

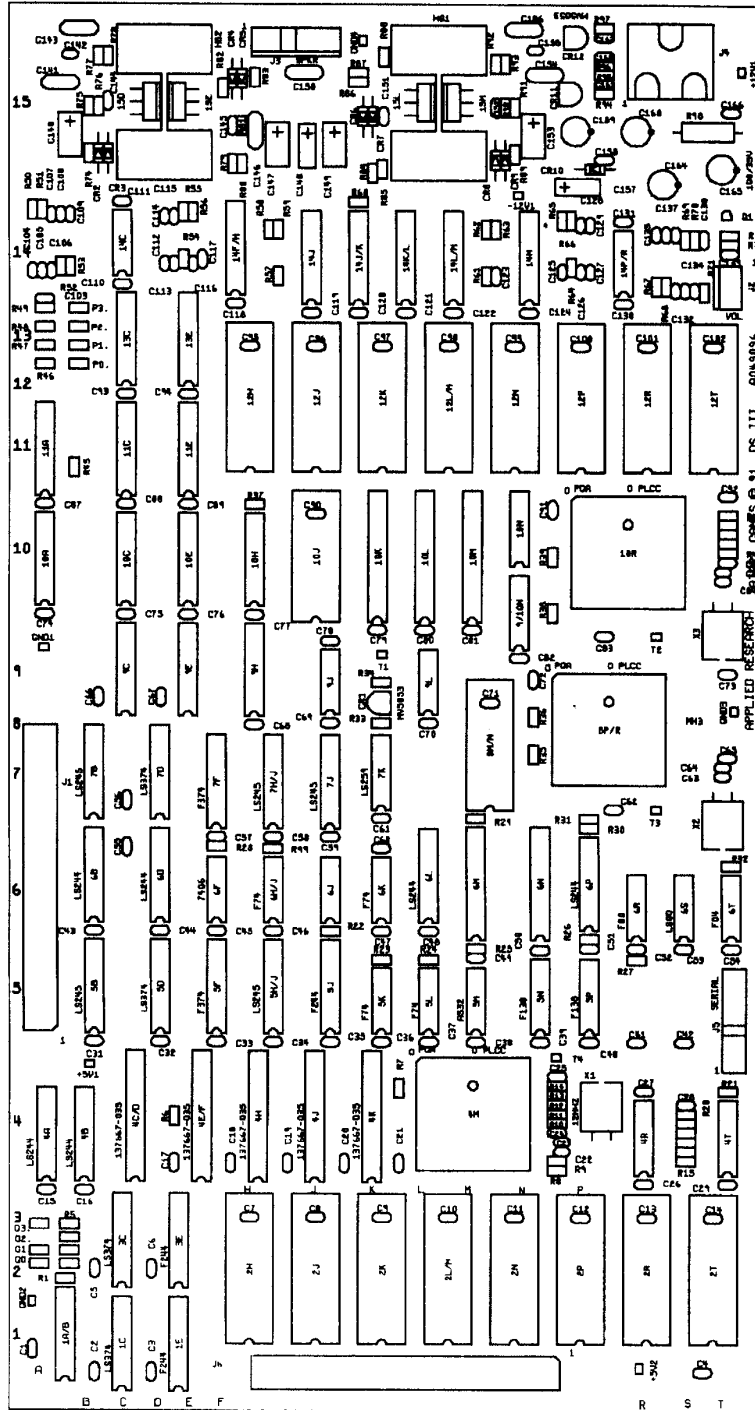


Figure 4-9 DS III PCB Assembly  
 A049095-01 A



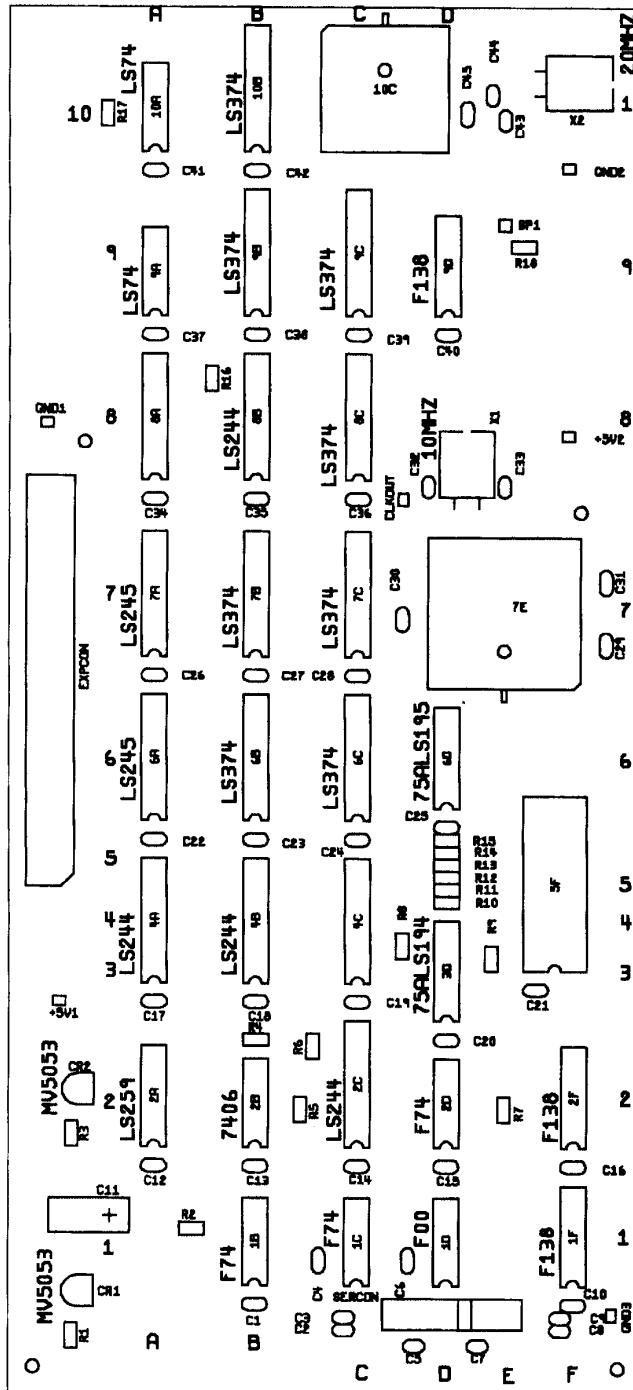


Figure 4-10 DSPCOM PCB Assembly  
A049348-01 A

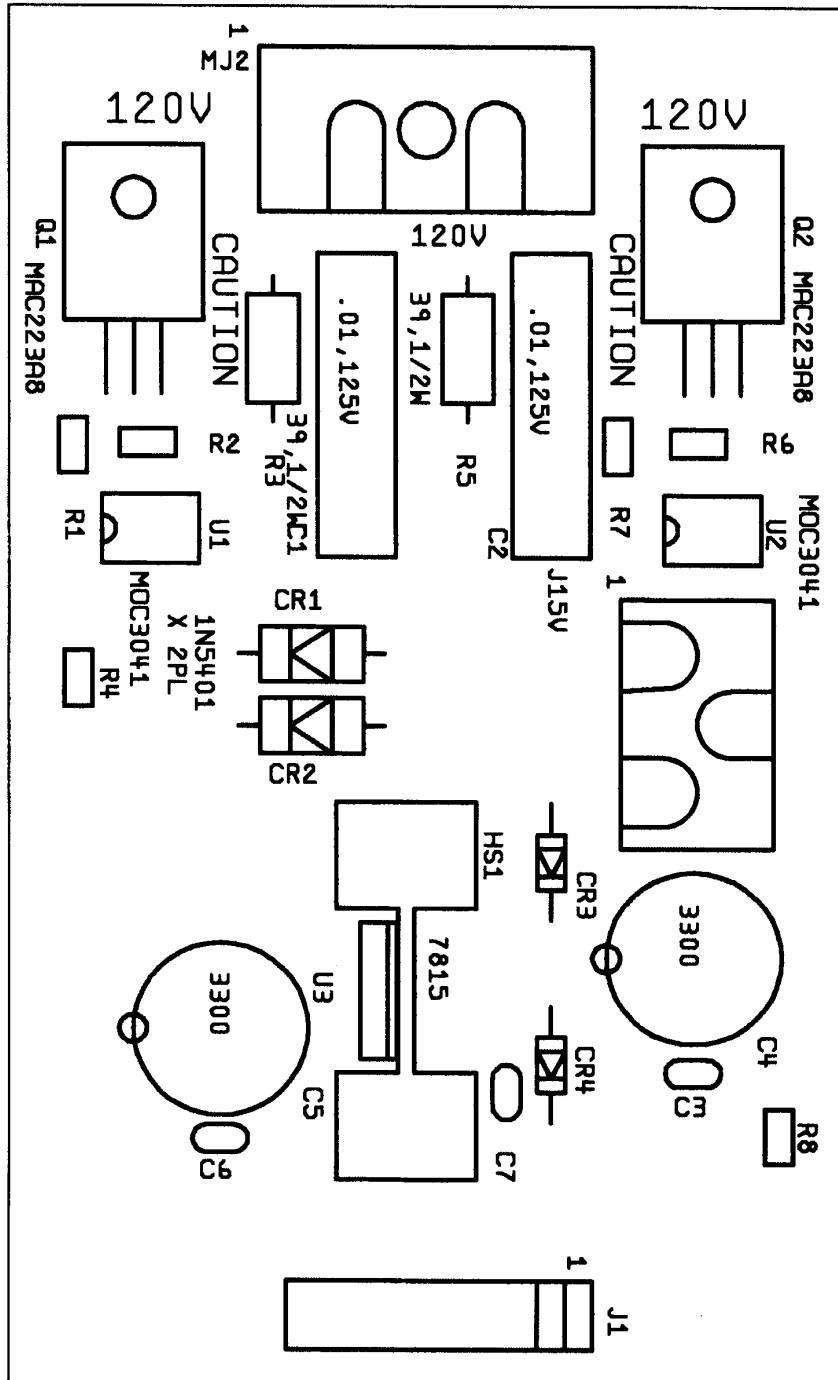


Figure 4-11 Steel Talons Rump Thump Assembly  
A049536-01 A

### Steel Talons Rump Thump PCB Assembly Parts List

Designator	Description	Part No.	Description	Designator	Part No.
(HS1)	Nut/Washer Assy, 6-32, Zinc	177026-1036			
(HS1)	Screw, Pan, 6-32X3/8, X-Rec, Cadmium	72-1606S	R1, R2	Resistor, 330 $\Omega$ , $\pm 5\%$ , 1/8 W	110027-331
C1, C2	Capacitor, .01 $\mu$ F, 125 V RMS, Ceramic Disc	120010-103	R3	Resistor, 39 $\Omega$ , $\pm 5\%$ , 1/2 W	110001-390
C3	Capacitor, .1 $\mu$ F, 50 V, +80%-20%, Ceramic	122002-104	R4	Resistor, 270 $\Omega$ , $\pm 5\%$ , 1/8 W	110027-271
C4	Capacitor, 3300 $\mu$ F, 25 V, Electrolytic	123003-338	R5	Resistor, 39 $\Omega$ , $\pm 5\%$ , 1/2 W	110001-390
CR1, CR2	Diode, 1N5401	131051-002	R6, R7	Resistor, 330 $\Omega$ , $\pm 5\%$ , 1/8 W	110027-331
CR3, CR4	Diode, 1N4001	131048-001	R8	Resistor, 270 $\Omega$ , $\pm 5\%$ , 1/8 W	110027-271
HS1	Heat Sink, TO-220, 1.5 X .5	178190-124			
J1	Connector, 11 Circuit, Header, .100 Ctr, Key 2	179118-011	U1, U2	Opto-Iso, Triac, MOC3041	138008-001
J15V	Connector, 6 Circuit, Header, .250 Ctr	179069-006	U3	Integrated Circuit, 7815	137598-001
MJ2	Connector, 3 Ckt, Header, .250 Ctr	179069-003	(HS1)	Compound, Thermal	107031-001
Q1, Q2	Triac, 600 V/25 A, MAC223A8	133053-001			

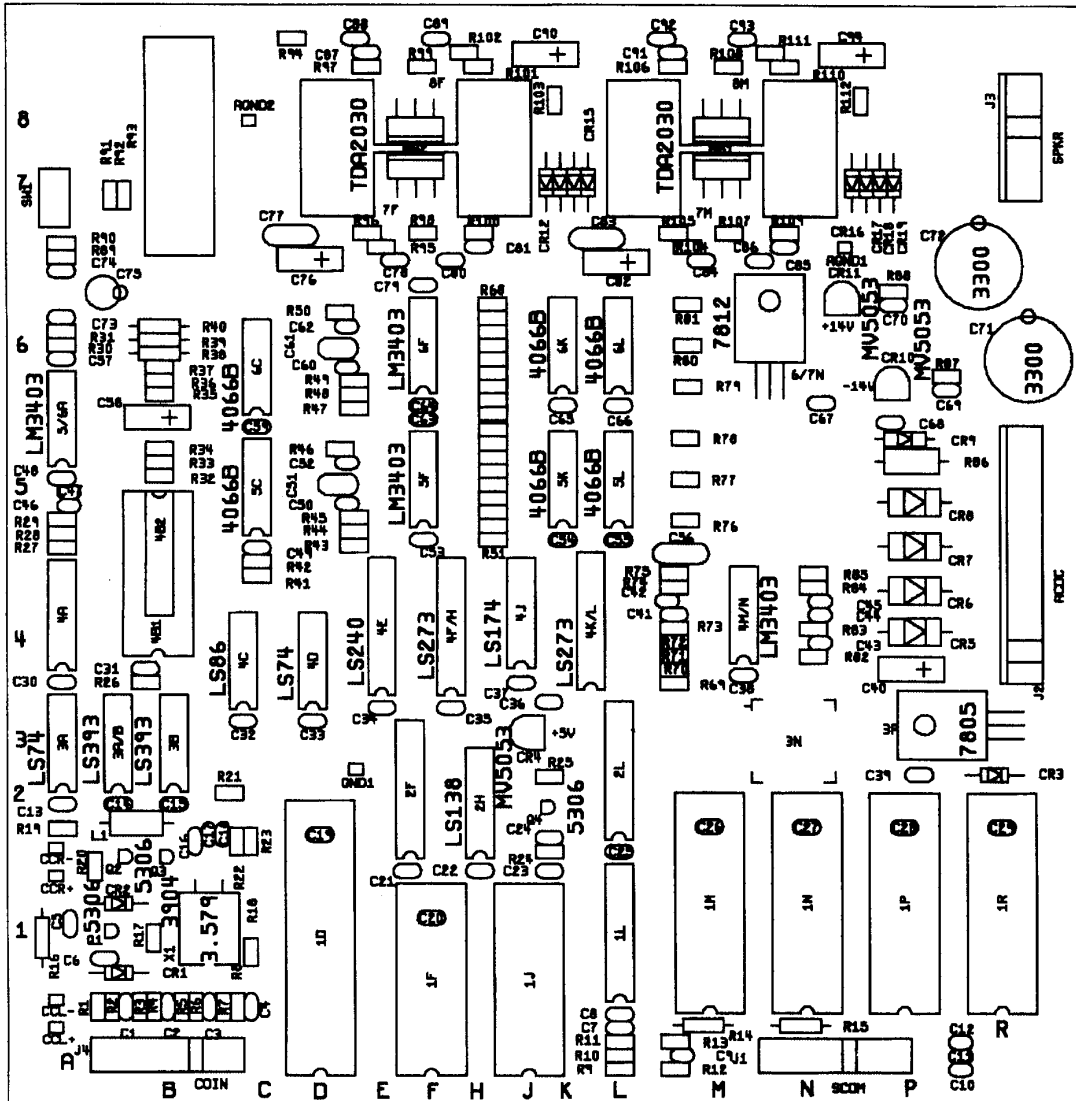


Figure 4-12 SAIIS (Audio) PCB Assembly  
A048479-XX A

### SAIS PCB Assembly Parts List

Part No.	Description	Designator	Part No.	Description	Designator
3N	Integrated Circuit, MSM6295	137607-001	2H	Integrated Circuit, 74LS138	137177-001
1D	Integrated Circuit, 6502A	137577-001	4J	Integrated Circuit, 74LS174	137122-001
1J	Integrated Circuit, RAM, 8KX8, 100 ns, 6	137535-004	4E	Integrated Circuit, 74LS240	137251-001
1L	Integrated Circuit, SCOM	137526-001	4F/H, 4K/L	Integrated Circuit, 74LS273	137040-001
4B1	Integrated Circuit, YM2151	137401-001	3B, 3A/B	Integrated Circuit, 74LS393	137146-001
4A	Integrated Circuit, YM3012	137402-001	3A, 4D	Integrated Circuit, 74LS74	137023-001
1M	EPROM, 200 ns, 128KX8	136087-5002	4C	Integrated Circuit, 74LS86	137079-001
1R	EPROM, 200 ns, 128KX8	136087-5005	3P	Integrated Circuit, 7805	137596-001
1F	EPROM, 200 ns, 64KX8	136087-5001	6/7N	Integrated Circuit, 7812	137597-001
2F	GAL16V8, 25 ns	136085-1038	5F, 6F, 4M/N,	Integrated Circuit, Quad Op-Amp,	137673-001
2L	GAL16V8, 25 ns	136085-1039	5/6A	LM3403	
C1-C4, C13- C16,C19-C39, C41, C48, C49, C53- C55, C57, C59, C63- C70, C74, C78-C81, C84-C89, C91-C93	Capacitor, .1μF, 50V, +80%-20%, Ceramic	122002-104	7F, 7M, 8F, 8M	Integrated Circuit, TDA2030	137301-001
C56	Capacitor, .1μF, 50V, 10%, Ceramic	122015-104	L1	Inductor, 100μH	141024-001
C77, C83	Capacitor, .22μF, 50V, 10%, Ceramic	122015-224	R16	Resistor, 0 Ω, 5%, 1/4W	110005-001
C43, C46, C47, C50, C60	Capacitor, 1000pF, 100V, 10%, Ceramic	122015-102	R97, R100, R106, R109	Resistor, 1 Ω, 5%, 1/8W	110027-010
C9-C12, C18	Capacitor, 100pF, 100V, 5%, Ceramic	122016-101	R52, R61, R85, R94	Resistor, 10 Ω, 5%, 1/8W	110027-100
C40, C58, C76, C82, C90, C94	Capacitor, 10μF, 25V, Electrolytic	124009-106	R24	Resistor, 100K Ω, 5%, 1/8W	110027-104
C52, C62	Capacitor, 2200pF, 50V, 10%, Ceramic	122015-222	R9, R18, R26, R51, R60, R75	Resistor, 10K Ω, 5%, 1/8W	110027-103
C51, C61	Capacitor, 3300pF, 50V, 5%, NPO	122019-332	R44, R45, R48, R49	Resistor, 12K Ω, 5%, 1/8W	110027-123
C71, C72	Capacitor, 3300μF, 25V, Electrolytic	123003-338	R22, R23	Resistor, 150K Ω, 5%, 1/8W	110027-154
C45	Capacitor, 3900pF, 50V, 10%, Ceramic	122015-392	R33, R36, R73	Resistor, 15K Ω, 5%, 1/8W	110027-153
C17	Capacitor, 39pF, 100V, 5%, Ceramic	122016-390	R76, R79	Resistor, 160K Ω, 5%, 1/8W	110027-164
C42, C44	Capacitor, 6800pF, 50V, 10%, Ceramic	122015-682	110001-181	Resistor, 180 Ω, 5%, 1/2W	R86
J4	Connector, 11 CKT, Header, .100 CTR, KEY 4	179118-011	R1, R3, R5, R7, R12, R13, R17, R20, R87-R89, R95, R102, R104, R111	Resistor, 1K Ω, 5%, 1/8W	110027-102
J1	Connector, 11 CKT, Header, .100 CTR, KEY 5	179118-011	R43, R47, R54, R63	Resistor, 20K Ω, 5%, 1/8W	110027-203
J2	Connector, 12 CKT, Header, .156 CTR, KEY 11	179213-012	R19	Resistor, 220 Ω, 5%, 1/8W	110027-221
J3	Connector, 6 CKT, Header, .156 CTR, KEY 3	179213-006	R25	Resistor, 240 Ω, 5%, 1/8W	110027-241
CR1, CR2, CR12-CR19	Diode, 1N4001	131048-001	R71	Resistor, 27K Ω, 5%, 1/8W	110027-273
CR5-CR8	Diode, 1N5401	131051-002	R74	Resistor, 2K Ω, 5%, 1/8W	110027-202
CR3	Diode, 1N5818	131025-001	R57, R66	Resistor, 3.3K Ω, 5%, 1/8W	110027-332
CR9	Diode, 1N754A, 6.8V, Zener	131002-001	R69, R70	Resistor, 3.9K Ω, 5%, 1/8W	110027-392
CR4, CR10, CR11	Diode, MV5053, Light-Emitting	131027-002	R34, R37	Resistor, 30K Ω, 5%, 1/8W	110027-303
HS1, HS2	Heat Sink, TDA2030	178190-032	R77, R80	Resistor, 330K Ω, 5%, 1/8W	110027-334
5C, 5K, 5L 6C, 6K, 6L	Integrated Circuit, 4066B	137580-001,	R59, R68, R96, R98, R99, R101, R103, R105, R107, R108, R110, R112	Resistor, 33K Ω, 5%, 1/8W	110027-333
			R56, R65	Resistor, 39K Ω, 5%, 1/8W	110027-393
			R2, R4, R6, R8, R10, R11, R21, R30, R90	Resistor, 470 Ω, 5%, 1/8W	110027-471

**SAHS PCB Assembly, Continued  
Parts List**

<b>Part No.</b>	<b>Description</b>	<b>Designator</b>	<b>Part No.</b>	<b>Description</b>	<b>Designator</b>
R53, R62	Resistor, 5.1K $\Omega$ , 5%, 1/8W	110027-512	1F, 1J	Socket, 28 Pin, .600	179257-028
R27	Resistor, 560 $\Omega$ , 5%, 1/8W	110027-561			
R82, R84	Resistor, 6.8K $\Omega$ , 5%, 1/8W	110027-682	1M, 1N, 1P, 1R	Socket, 32 Pin, .600	179257-032
R78, R81	Resistor, 620K $\Omega$ , 5%, 1/8W	110027-624	1D	Socket, 40 Pin, .600	179257-040
			CCL+, CCL-,	Test Point	179051-001
R32, R35, R72	Resistor, 7.5K $\Omega$ , 5%, 1/8W	110027-752	CCR+, CCR-,	GND1,	
R55, R64	Resistor, 82K $\Omega$ , 5%, 1/8W	110027-823	AGND1, AGND2		
R198, 199, R200, R201 R202, R203	Resistor, 100K $\Omega$ , 5%, 1/8W	110027-104	Q3	Transistor, 2N3904	133041-001
			Q1, Q2, Q4	Transistor, 2N5306	133033-001
4A	Socket, 16 Pin, .300	179259-016	X1	Crystal, 3.579 MHz	144007-001
1L, 2F, 2L	Socket, 20 Pin, .300	179259-020	(HS1, 2)	Screw, Pan-Head, 6-32 x 3/8, Zinc	72-1606S
4B1	Socket, 24 Pin, .600	179257-024	(HS1, 2)	Nut-Washer Assy., 6-32, Zinc	177026-1036
			(HS1, 2)	Compound, Thermal	107031-001

